

Lampiran 1. Peta Lokasi *Assembly Point* FKM UI

[TM.5 = 328.404 m ²]	[TM.13 = 84.200 m ²]
[TM.6 = 2423.21 m ²]	[TM.14 = 968.891 m ²]
[TM.7 = 1199.34 m ²]	[TM.15 = 741.553 m ²]
[TM.8 = 291.406 m ²]	[TM.16 = 2150.49 m ²]

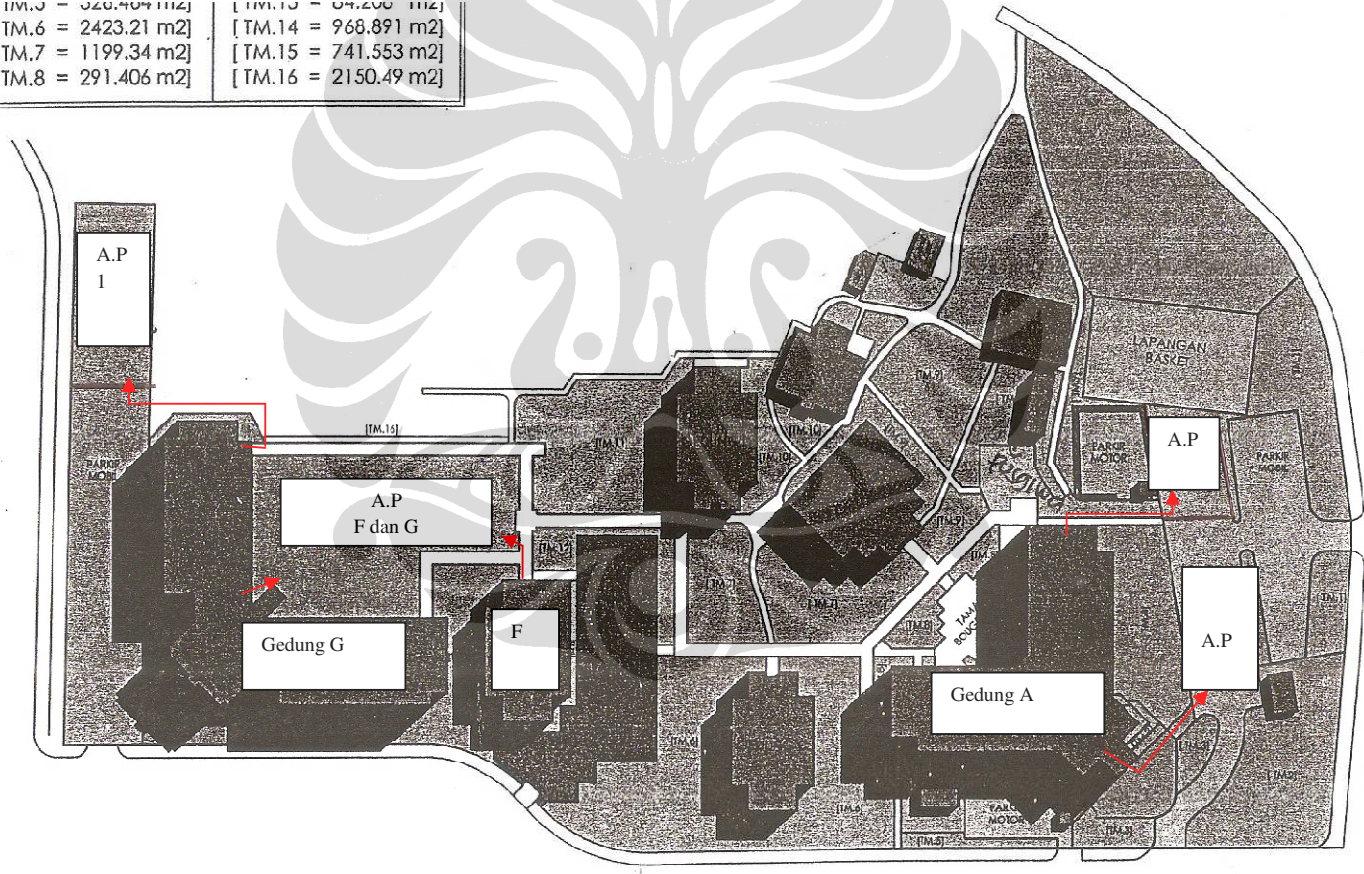

Lampiran 2. Peta Lokasi *Assembly Point* Gedung A FKM UI

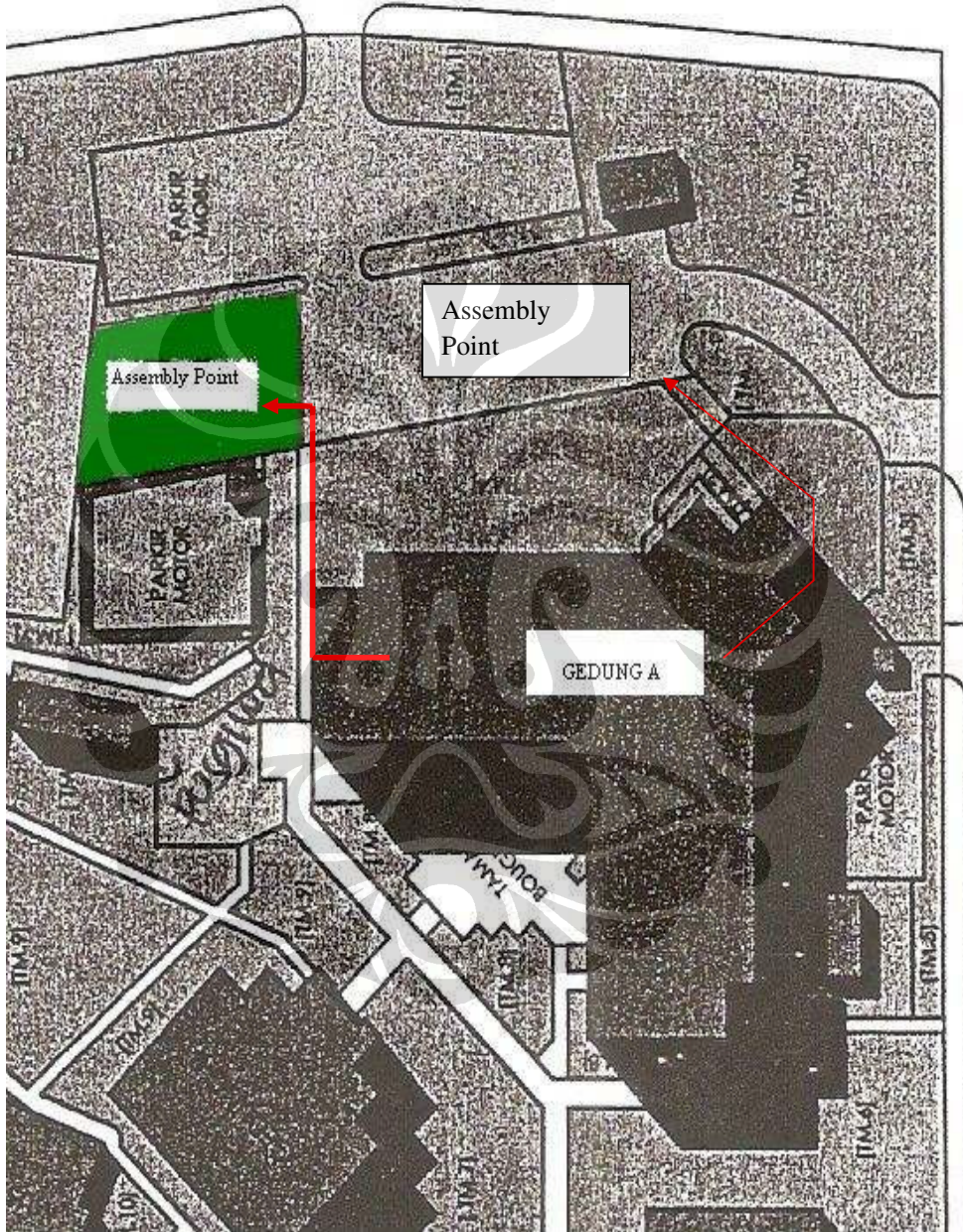

Lampiran 3: Rute Evakuasi di Dept. Biostat. ke *Assembly Point 2*

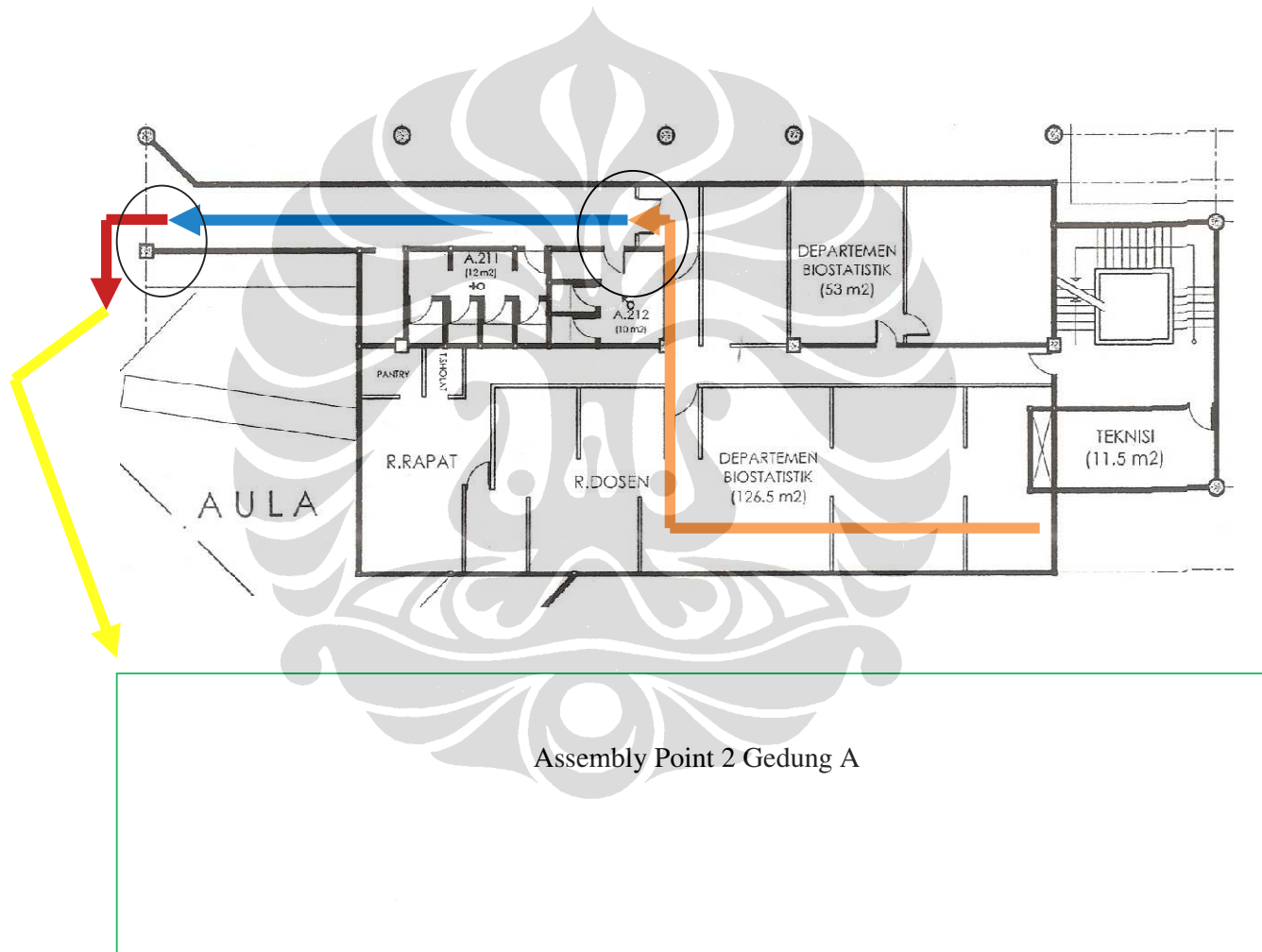

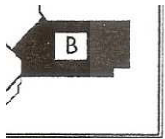

Handwritten notes: 14,5, 7,85, 5,3125

Lampiran 4: Rute Evakuasi di 303 ke Assembly Point 1

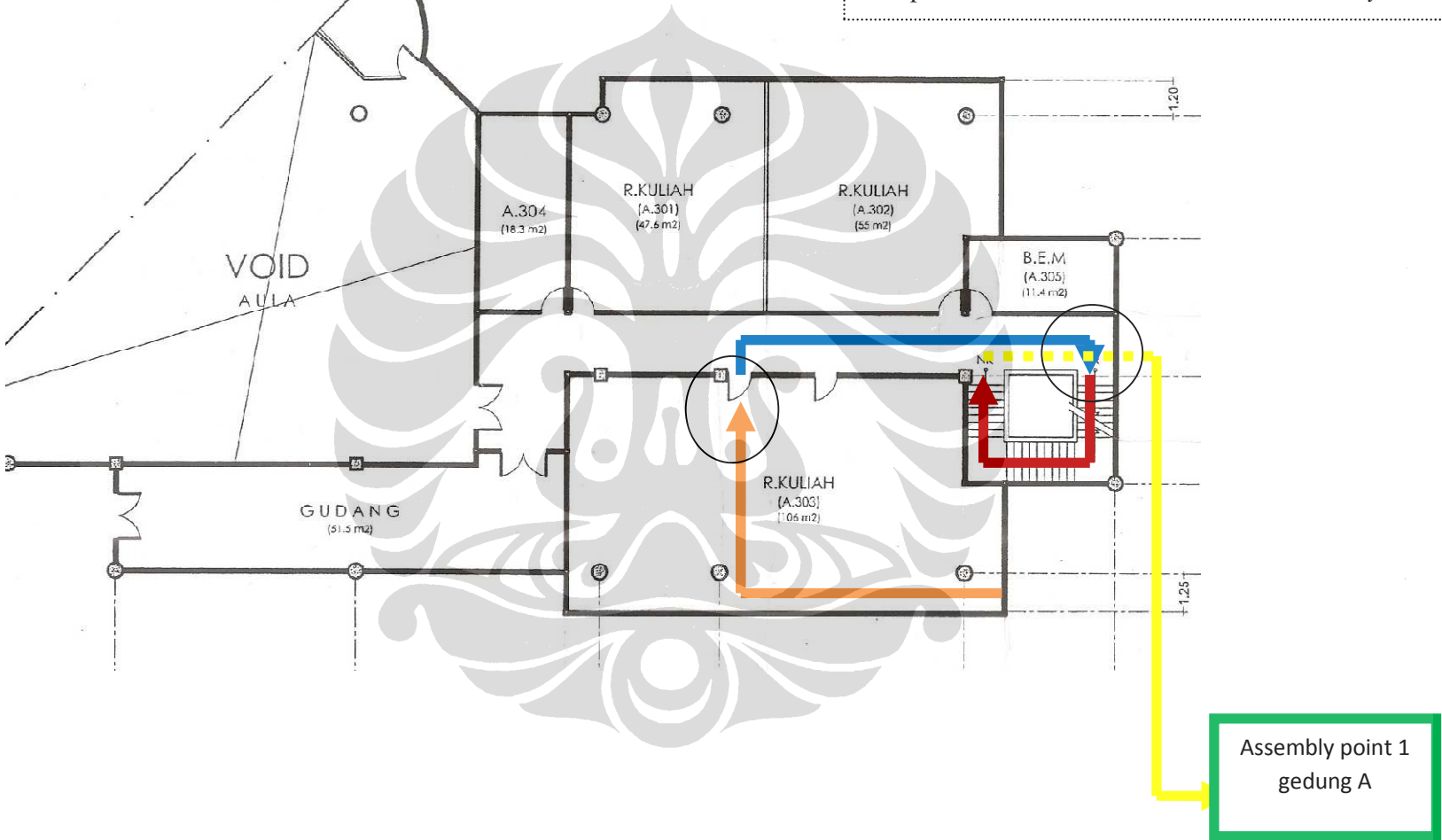

Lampiran 5: Rute Evakuasi di A302 ke *Assembly Point 2*

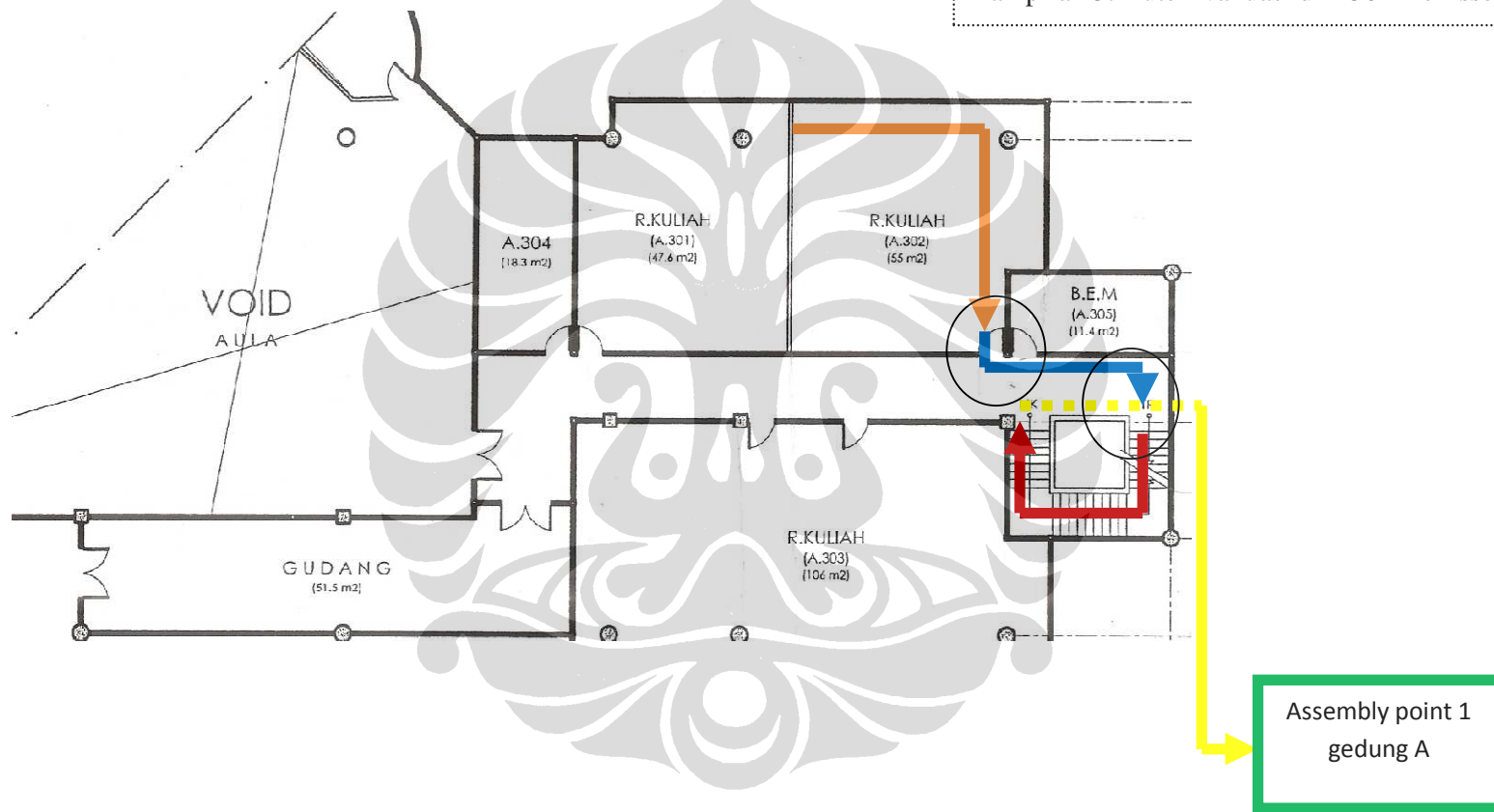

Lampiran 6: Rute Evakuasi di A301 ke *Assembly Point* 1

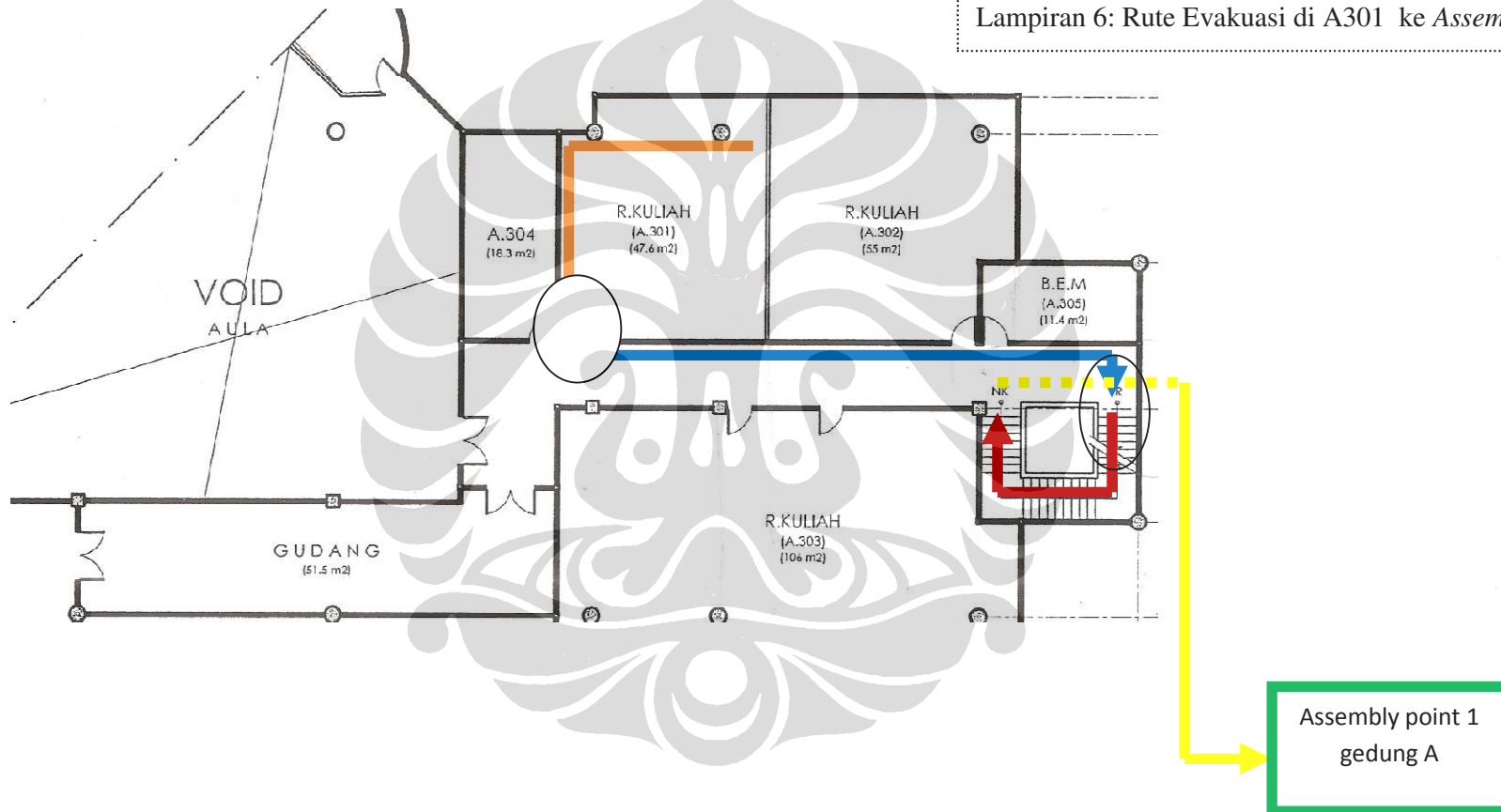

Lampiran 7: Rute Evakuasi di A202 ke *Assembly Point 1*

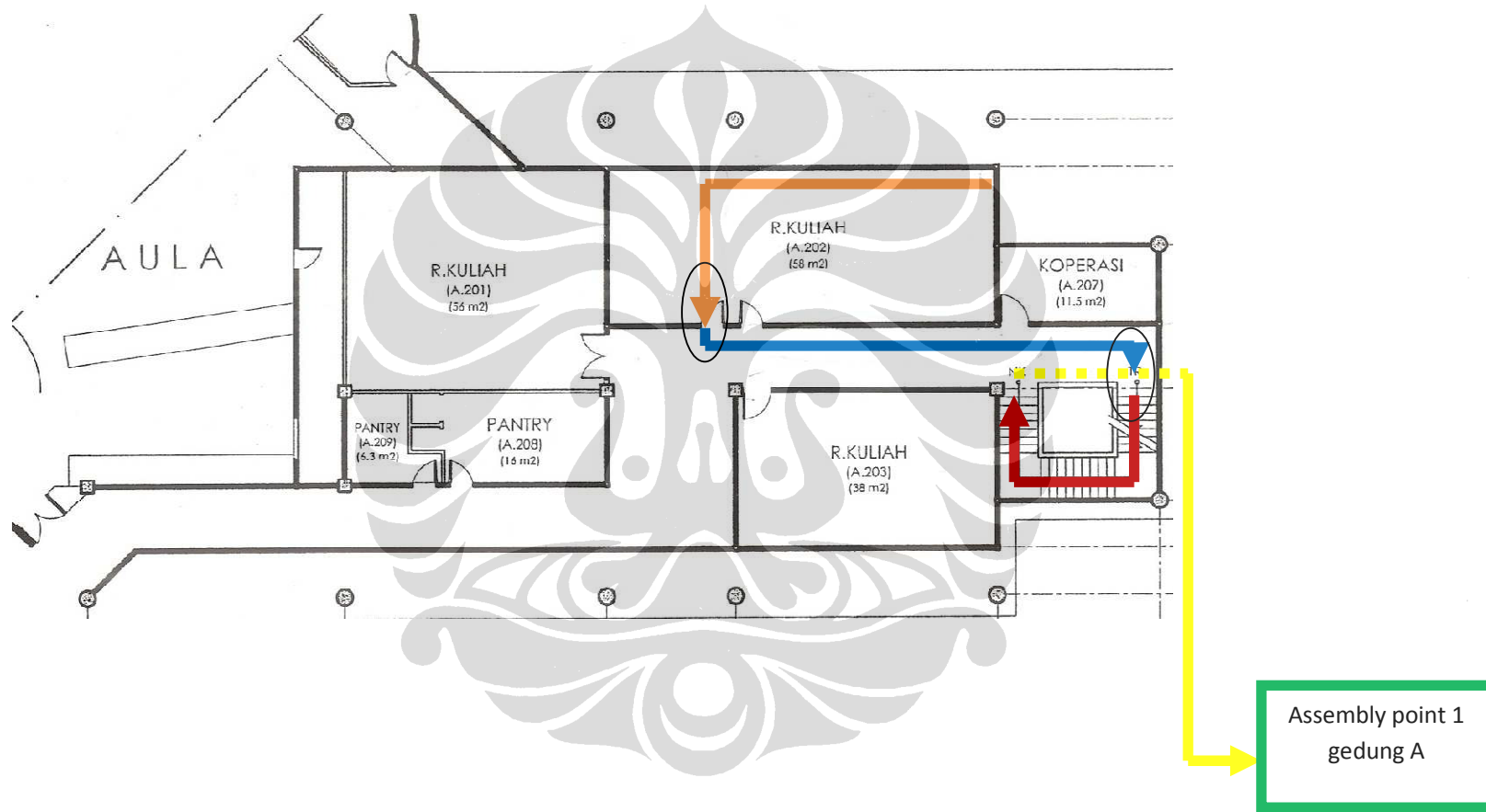

Lampiran 8: Rute Evakuasi di A203 ke *Assembly Point* 1

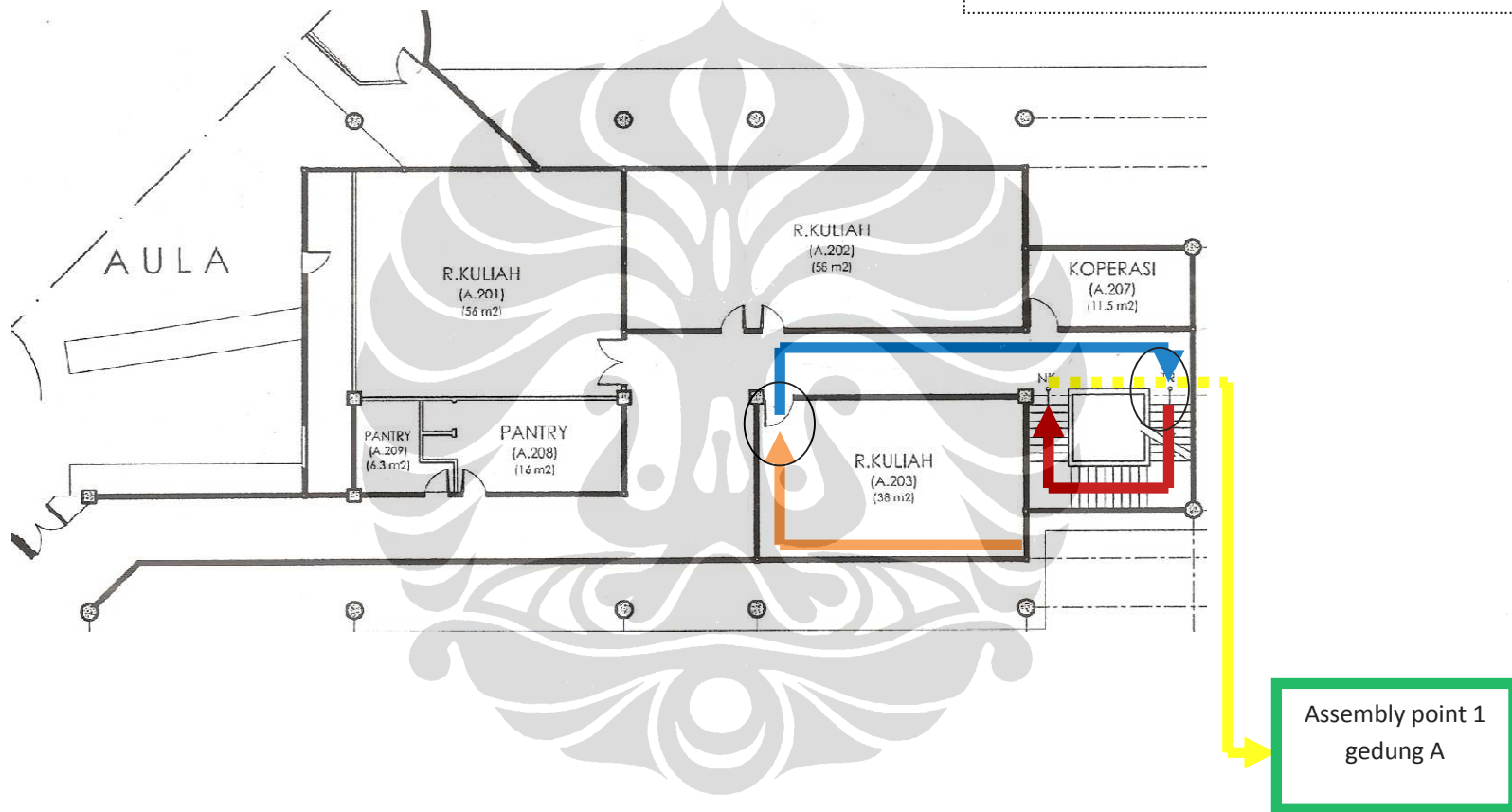

Lampiran 9: Rute Evakuasi di A201 ke *Assembly Point* 1

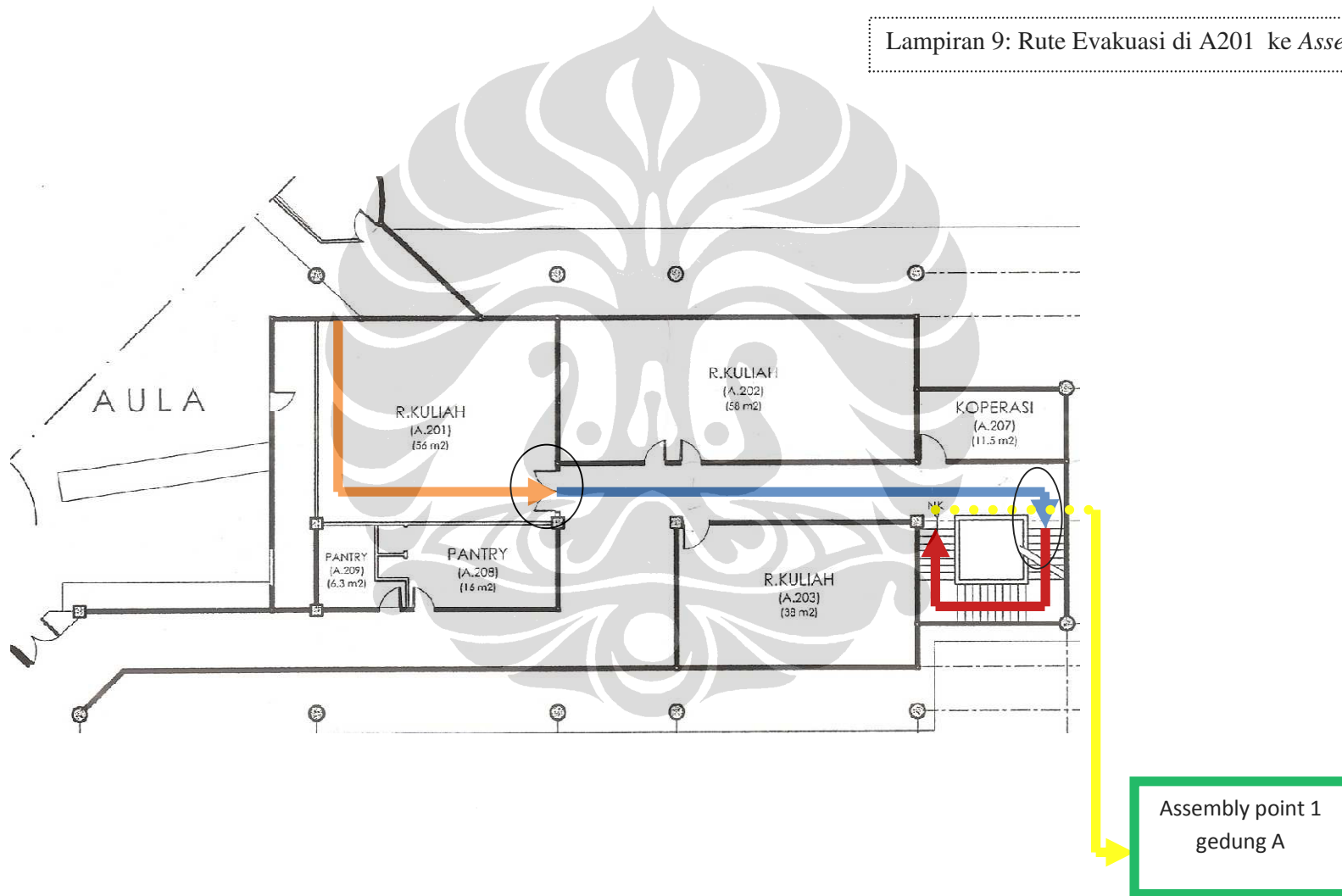

Lampiran 10: Rute Evakuasi di Dept. Epid ke *Assembly Point 1*

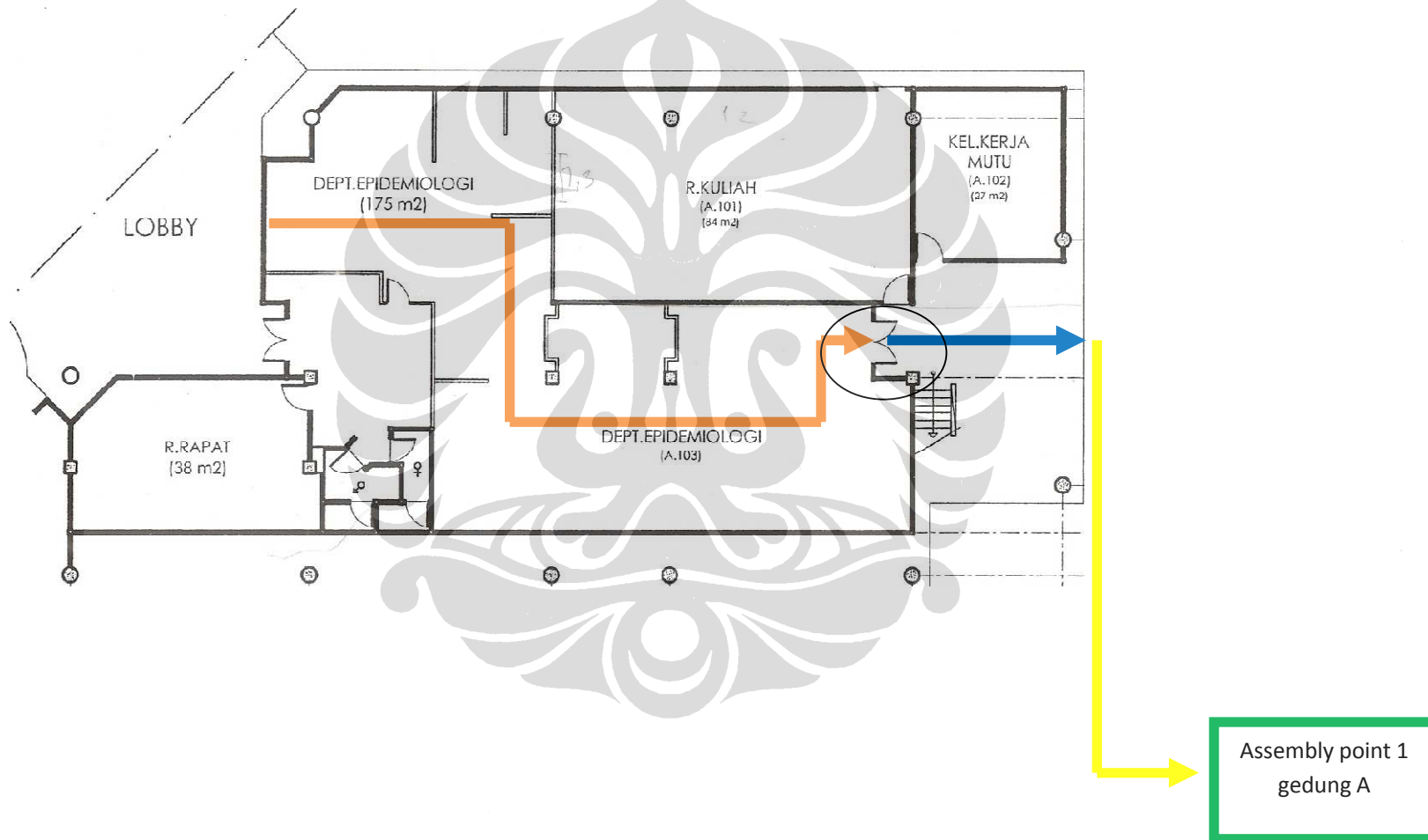

Lampiran11. Peta Lokasi *Assembly Point* Gedung F FKM UI

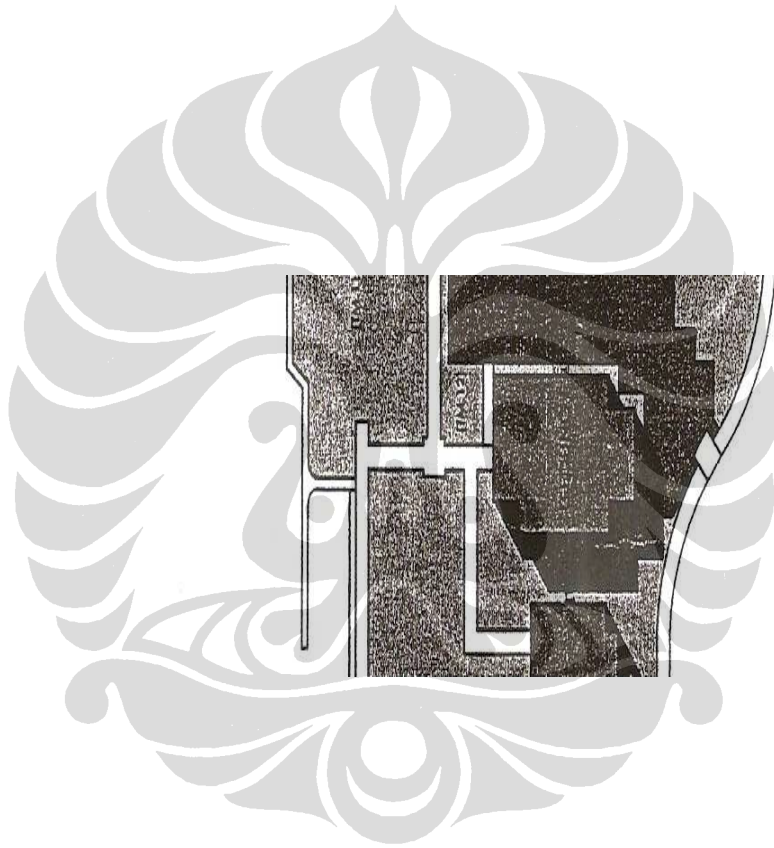

Lampiran12. Rute Evakuasi di F303 ke Assembly Point

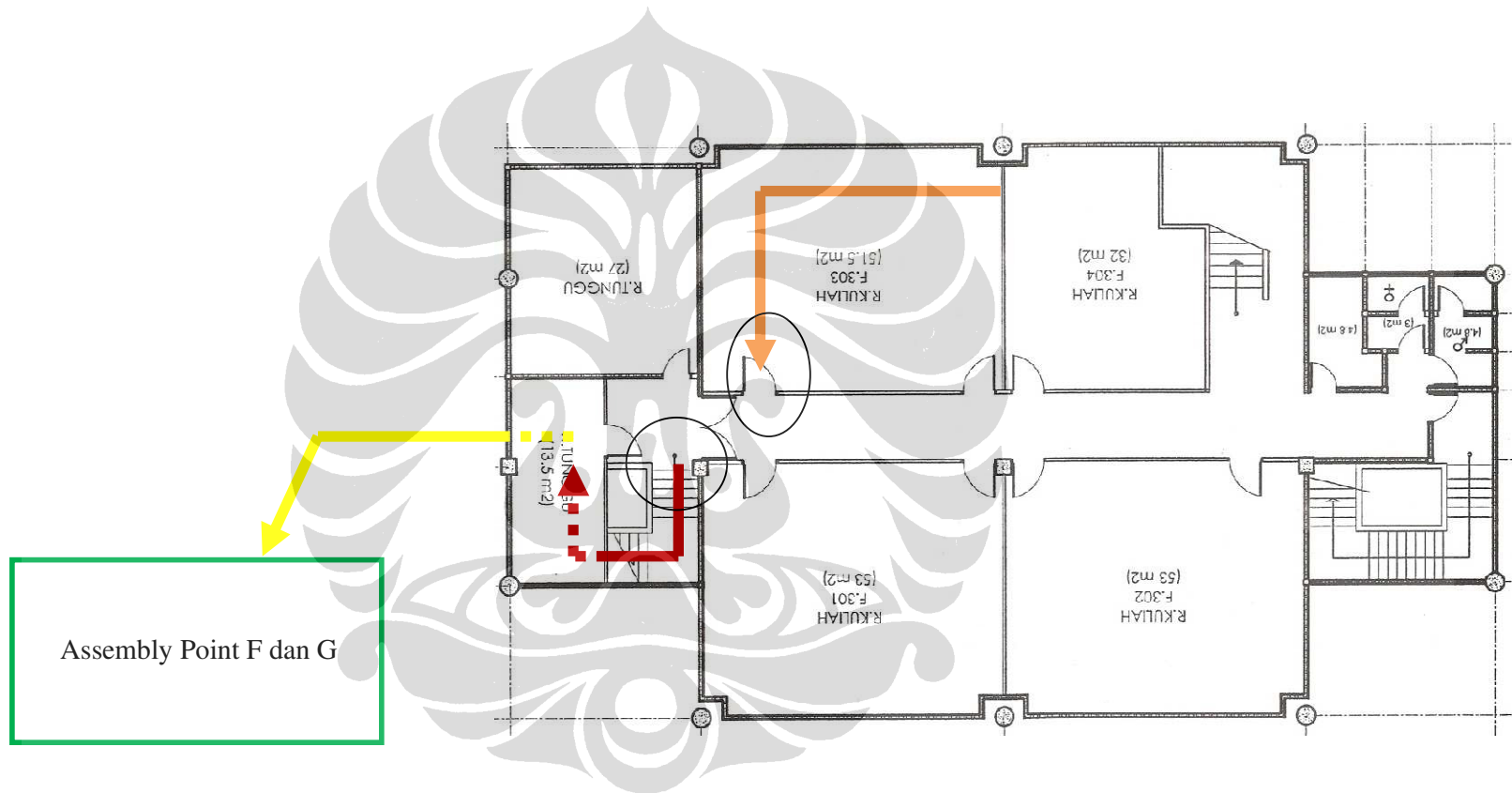

Lampiran13. Rute Evakuasi di F302 ke Assembly Point

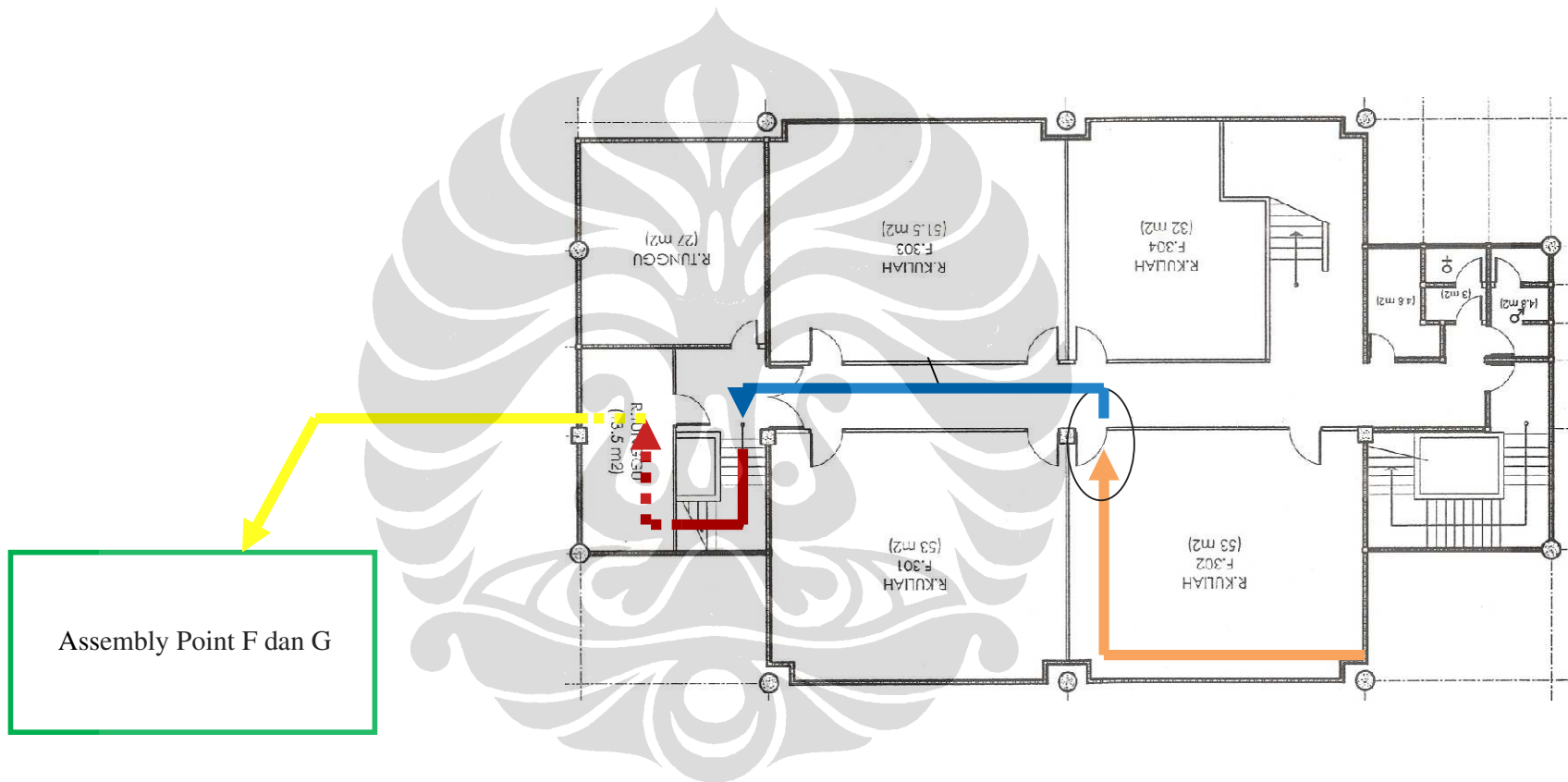

Lampiran14. Rute Evakuasi di F301 ke Assembly Point

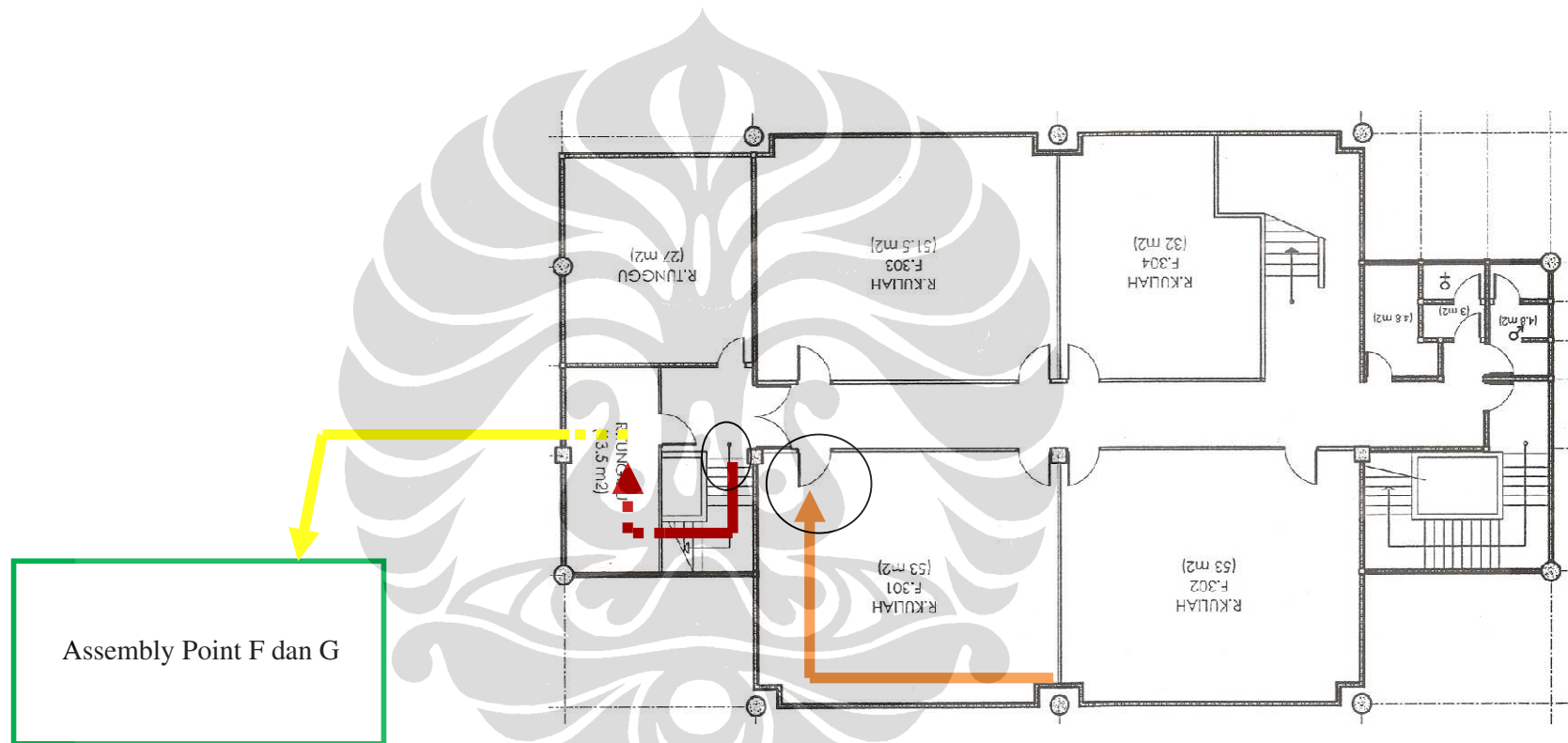

Lampiran15. Rute Evakuasi di F304 ke Assembly Point

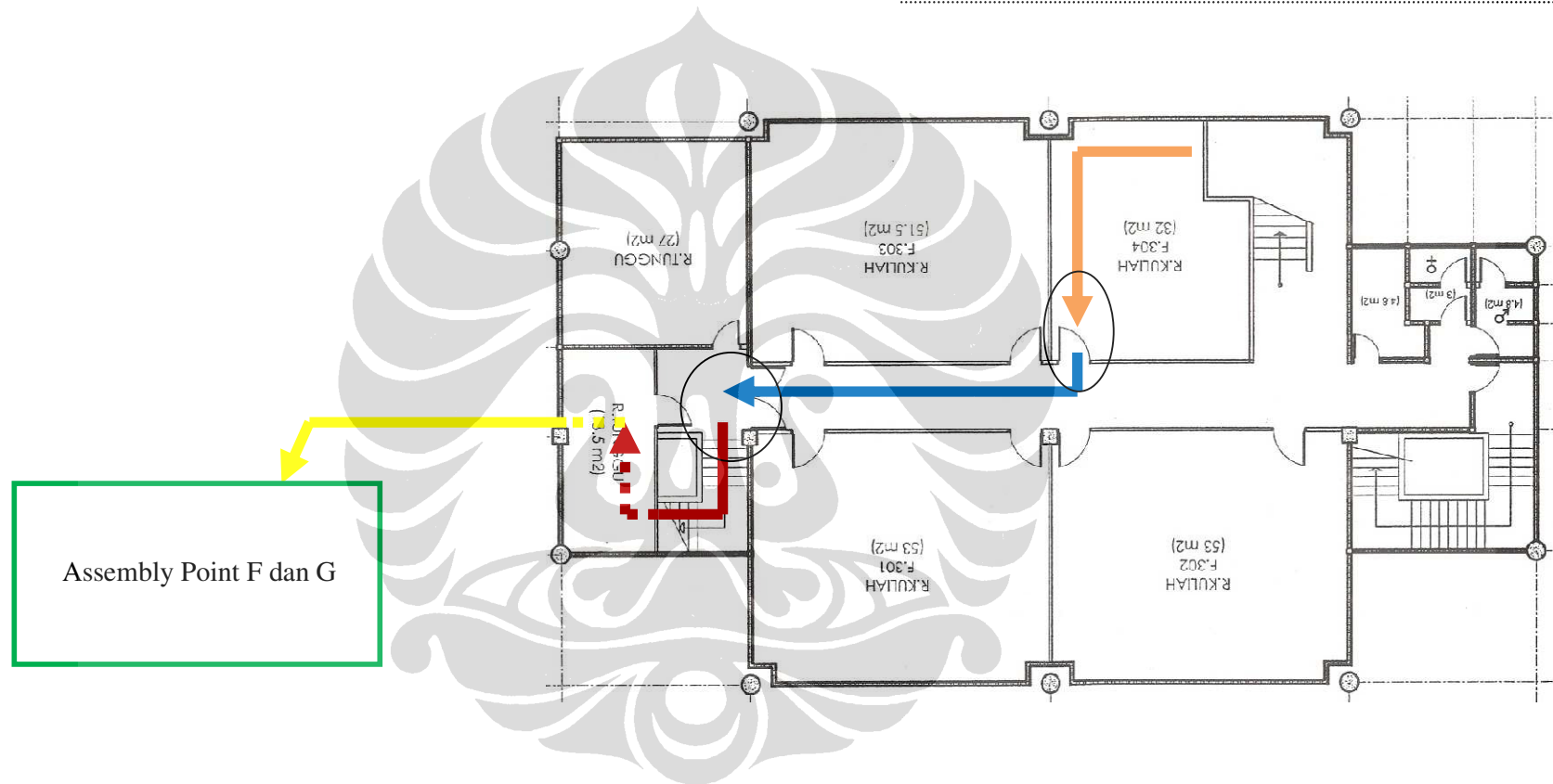

Lampiran16. Rute Evakuasi di Dept. AKK ke Assembly Point

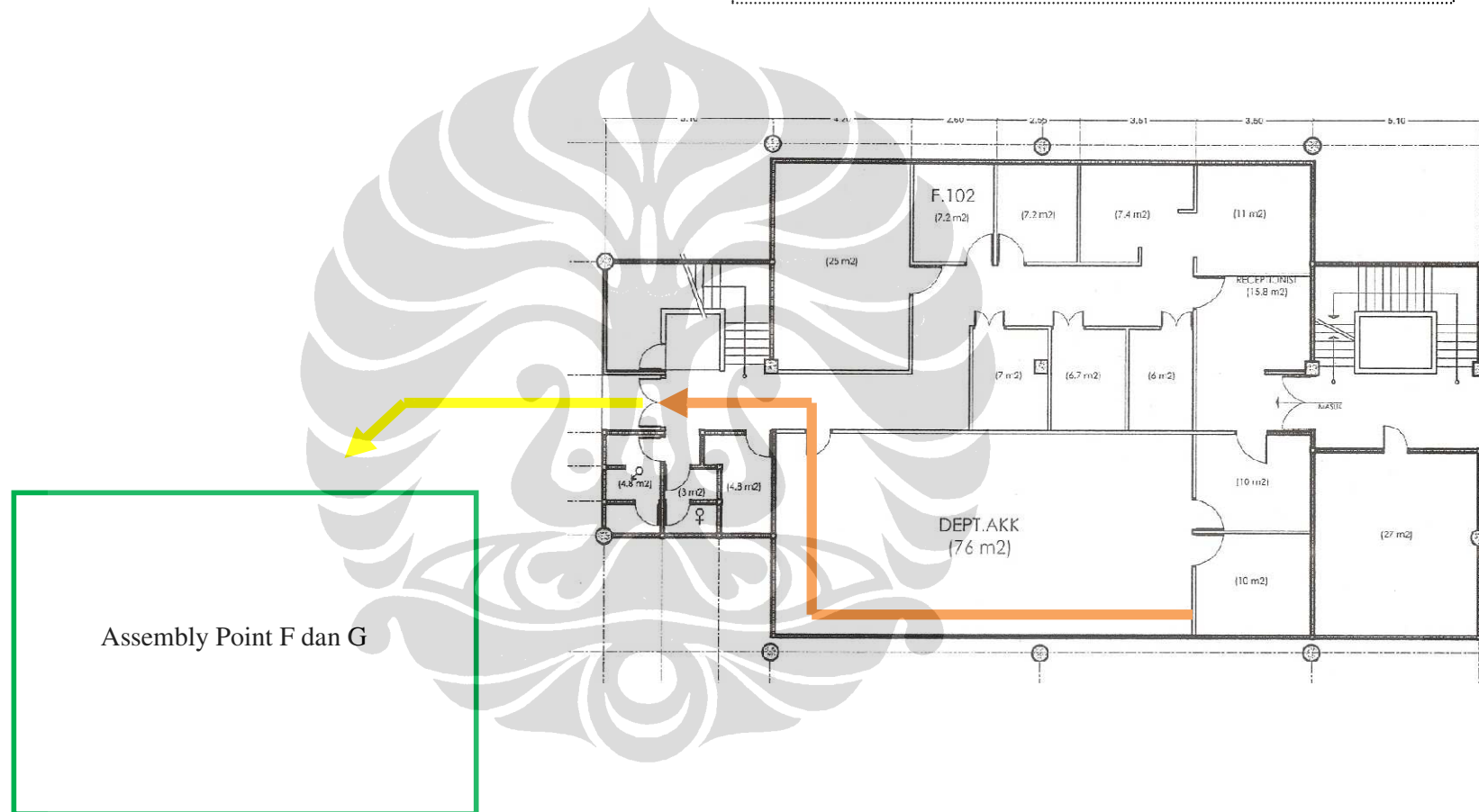

Lampiran17. Rute Evakuasi di Dept. Gizi ke Assembly Point

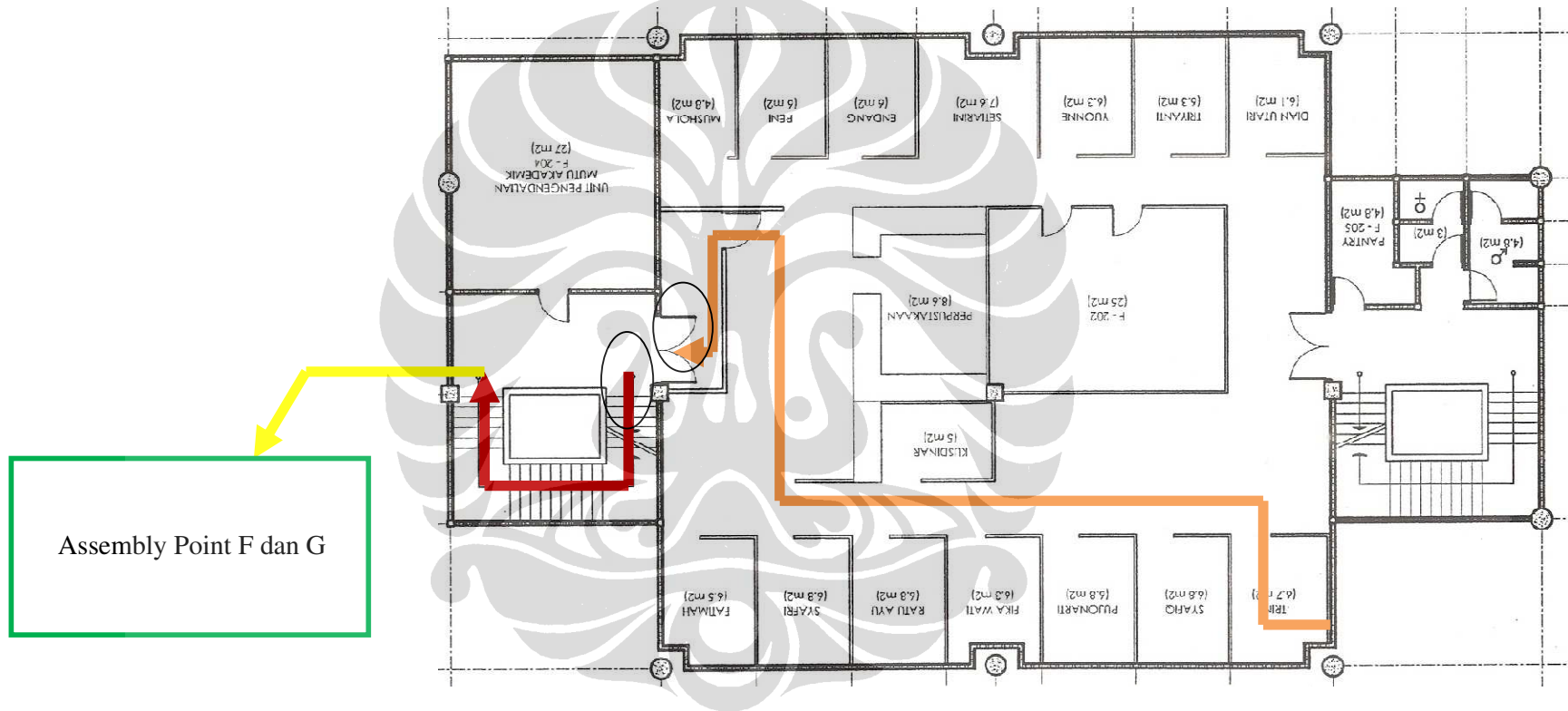

Lampiran 18. Peta Lokasi *Assembly Point* Gedung G FKM U

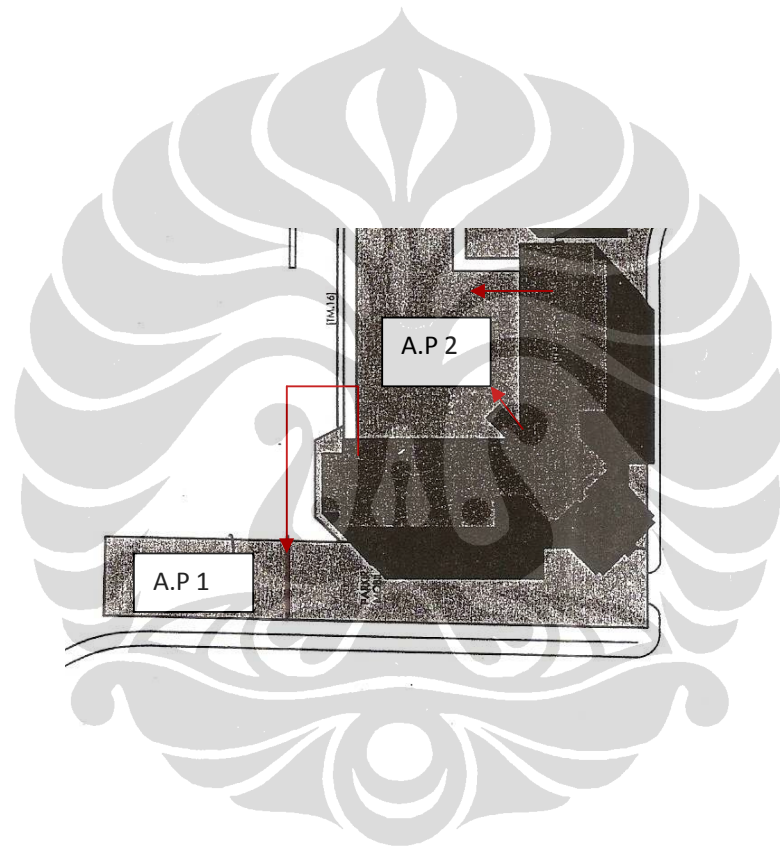

Lampiran 19. Rute Evakuasi di G105 ke Assembly Point 1

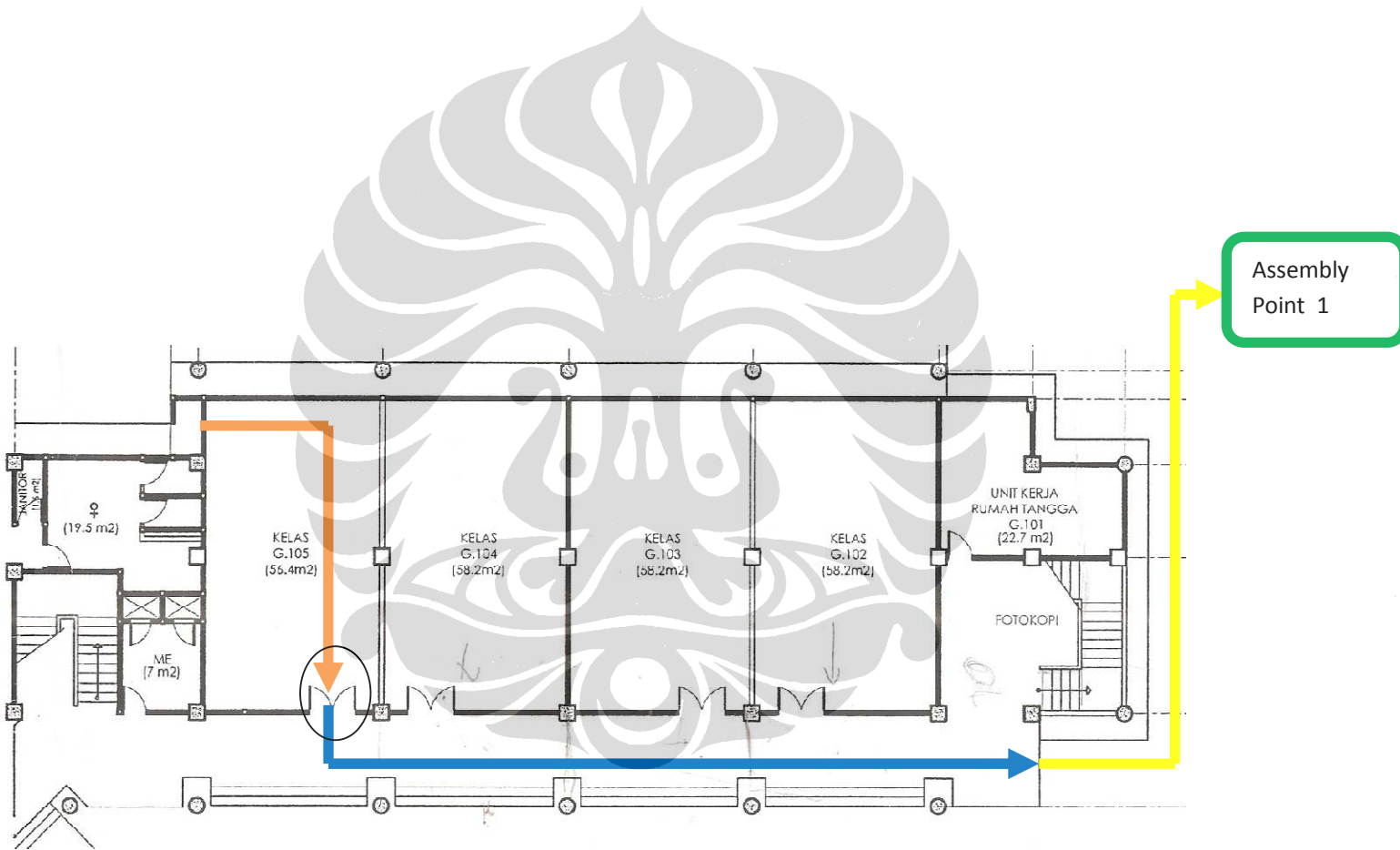

Lampiran 21. Rute Evakuasi di G103 ke Assembly Po

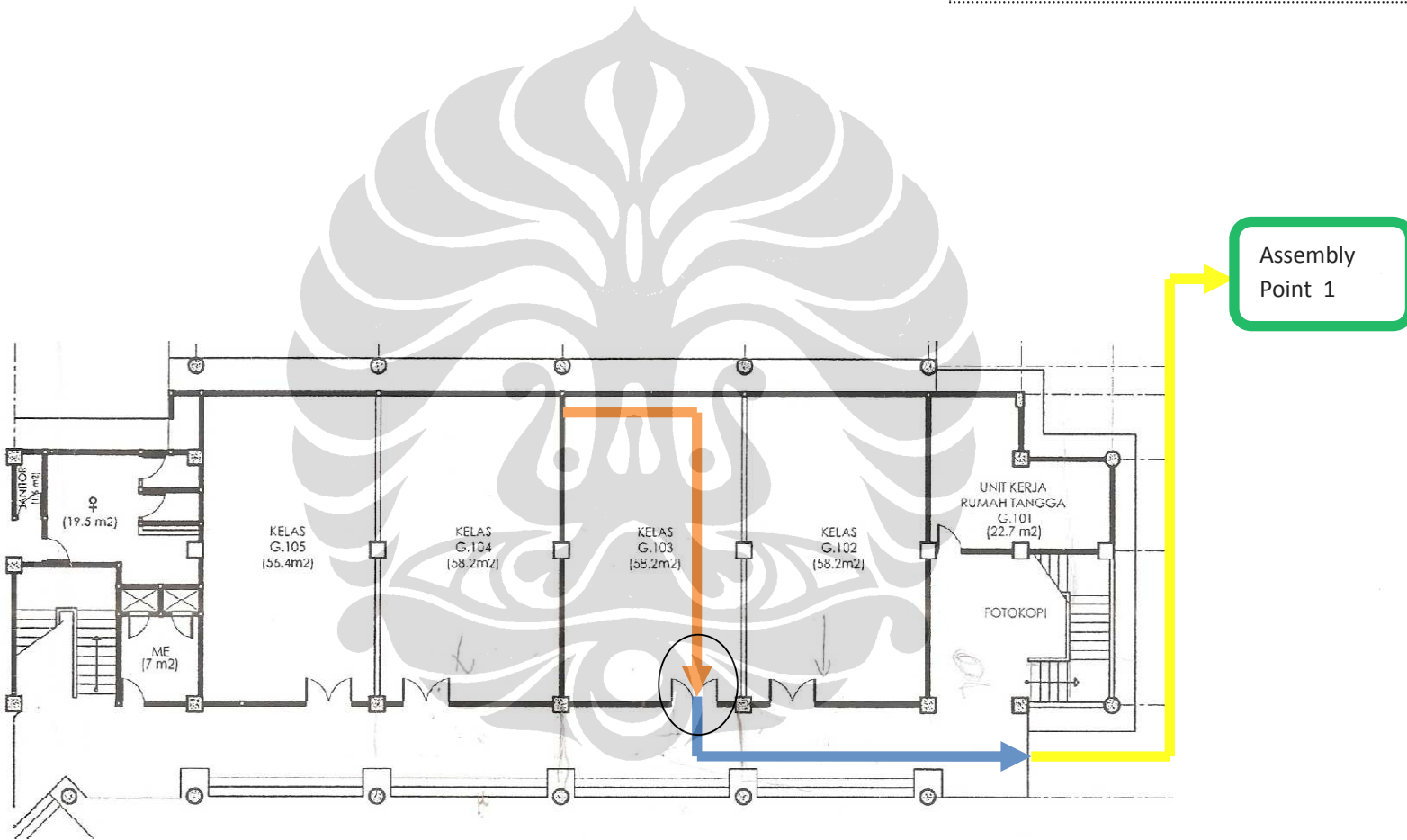

Lampiran 23. Rute Evakuasi di G105 ke Assembly Pc

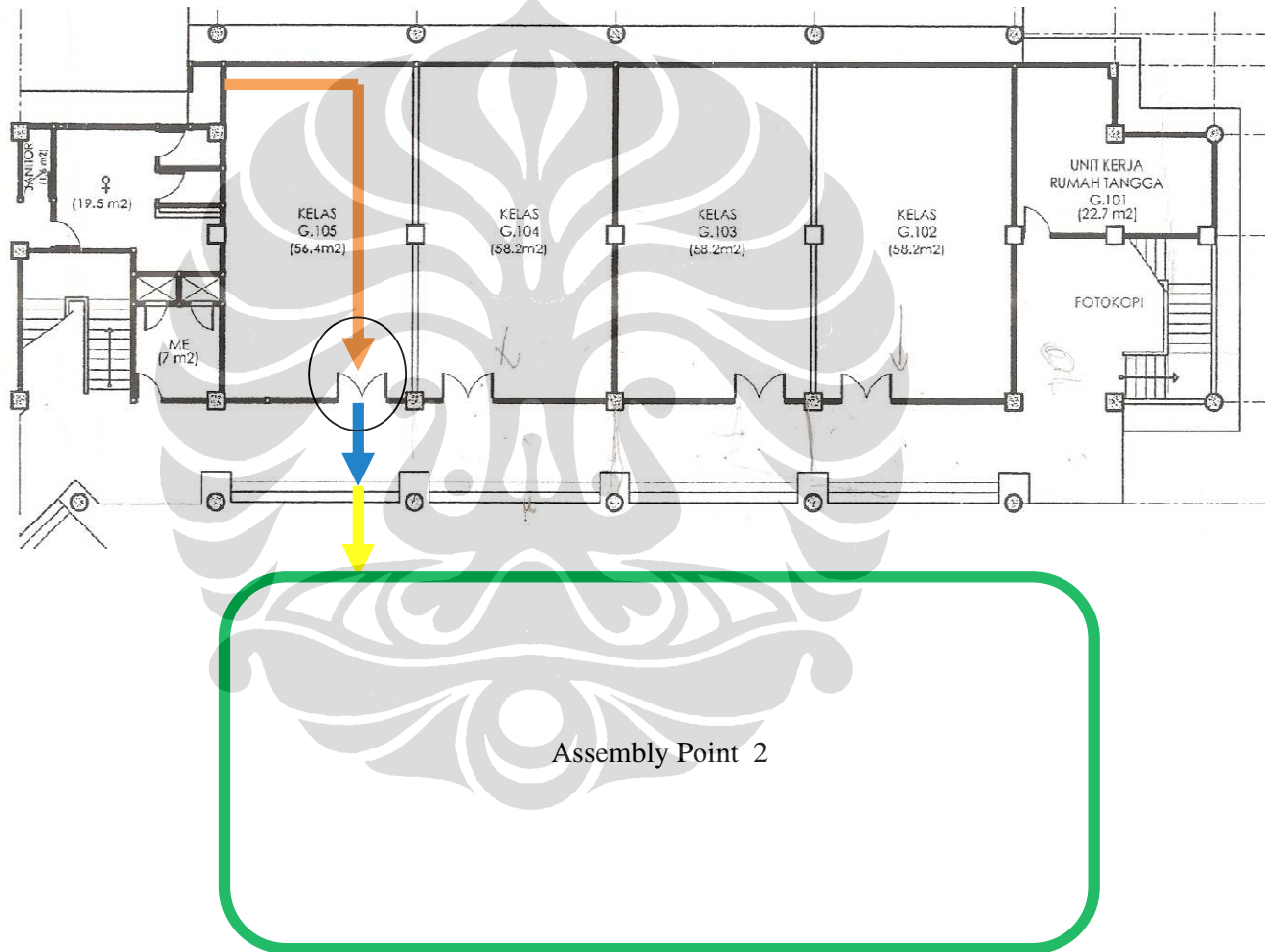

Lampiran 24: Rute Evakuasi di Ruang G104 ke *Assembly Point 2*

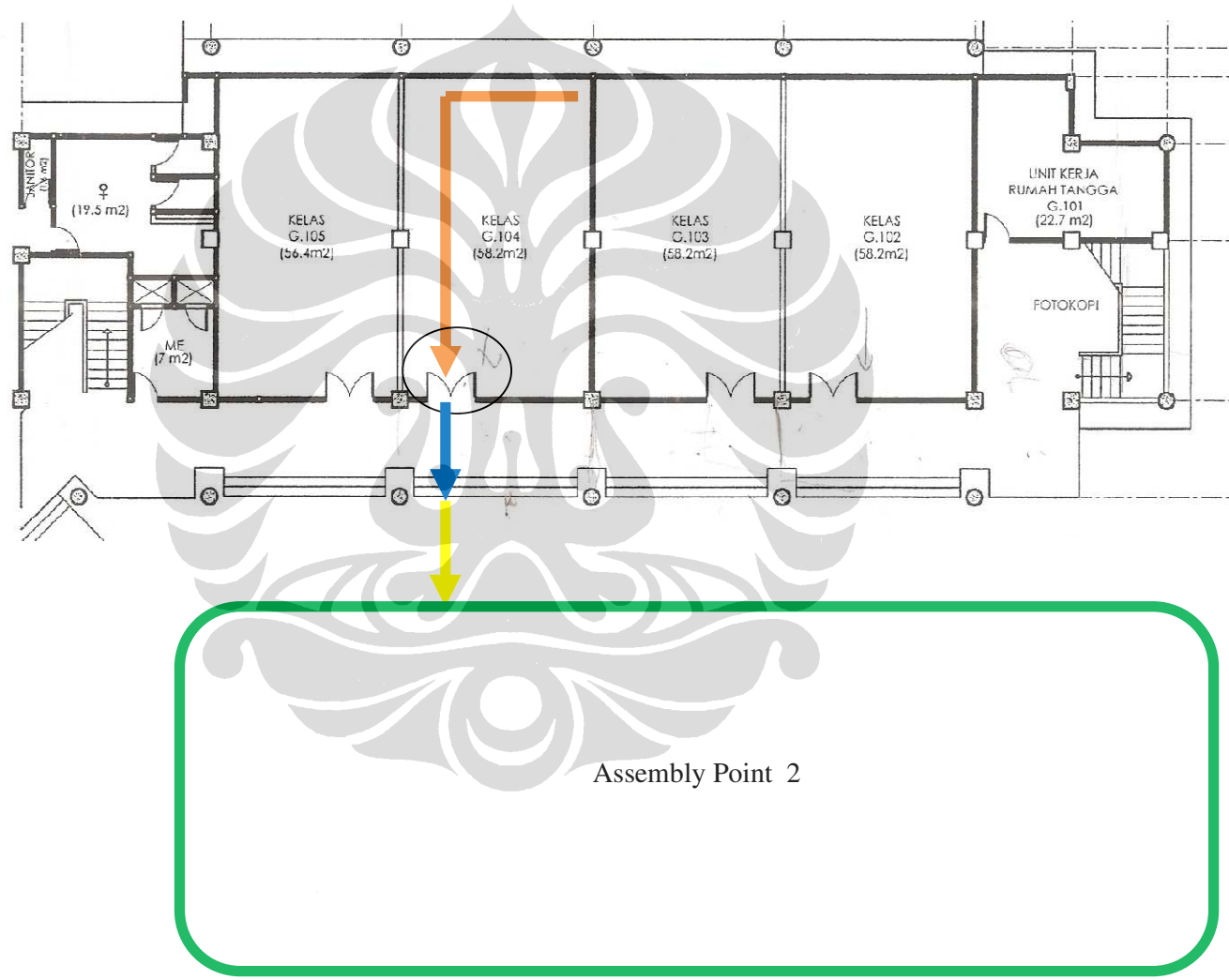

Lampiran 25. Rute Evakuasi di G103 ke Assembly Point

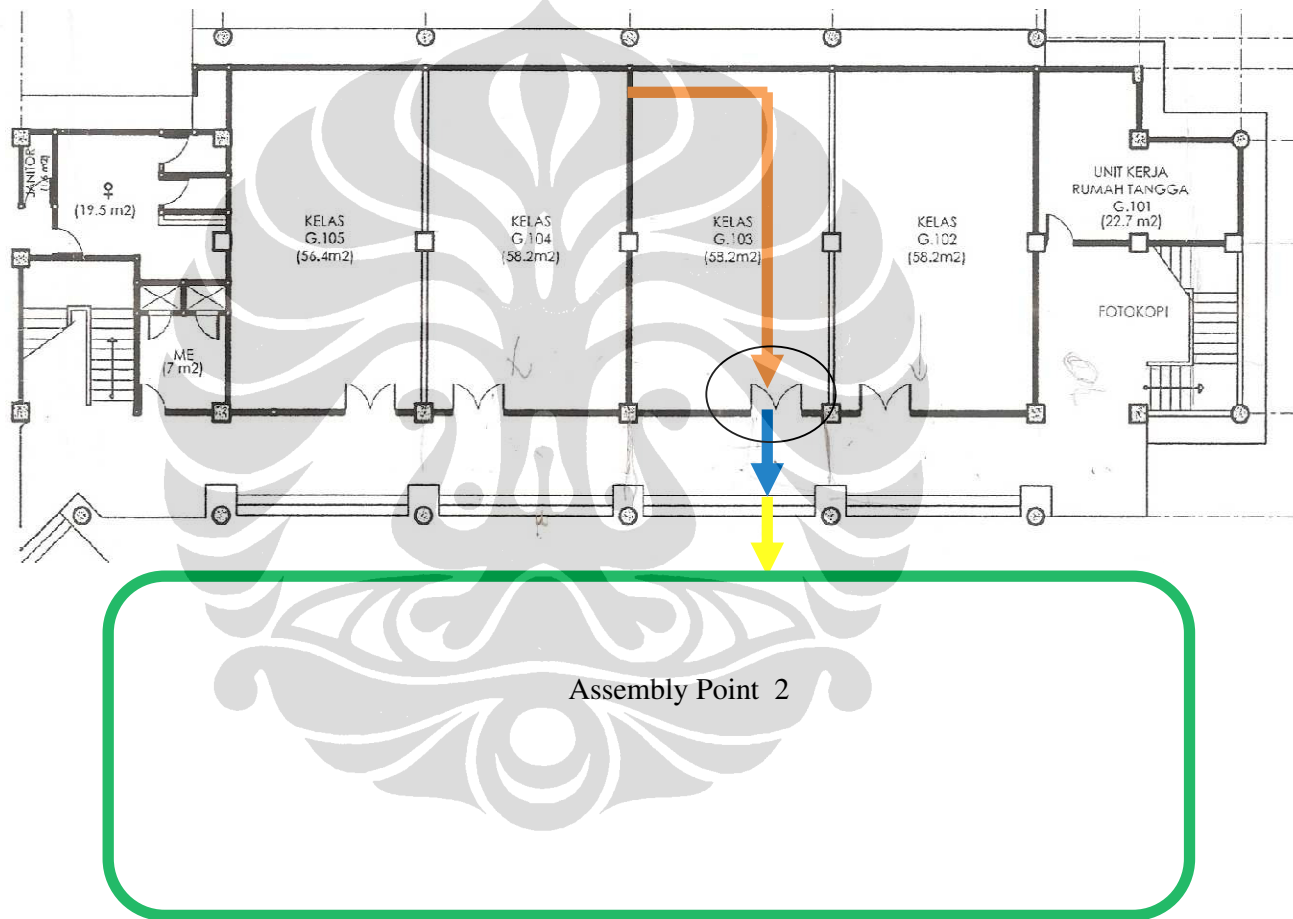

Lampiran 26. Rute Evakuasi di G102 ke Assembly Point 2

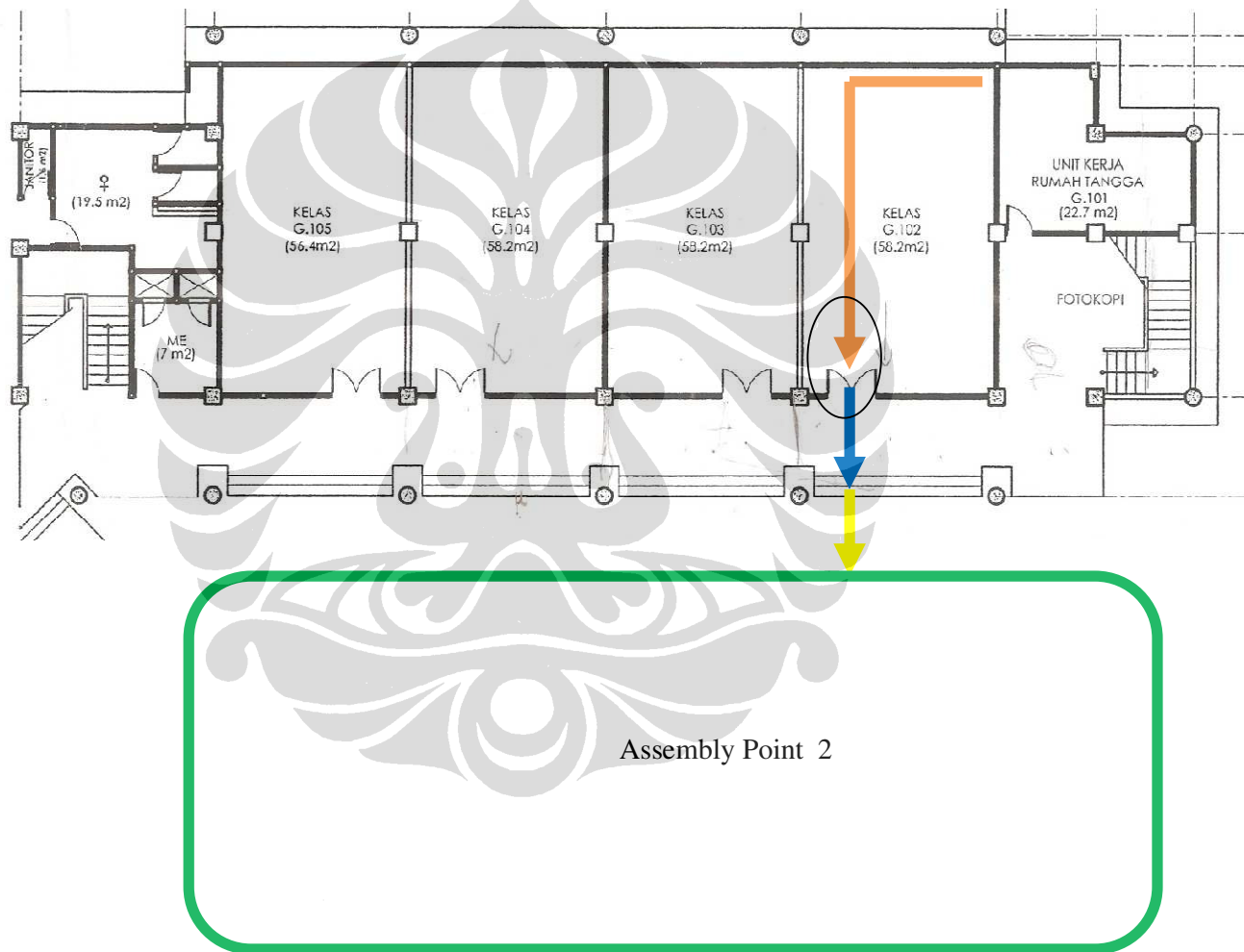

Lampiran 27. Rute Evakuasi di G205 ke Assembly Point

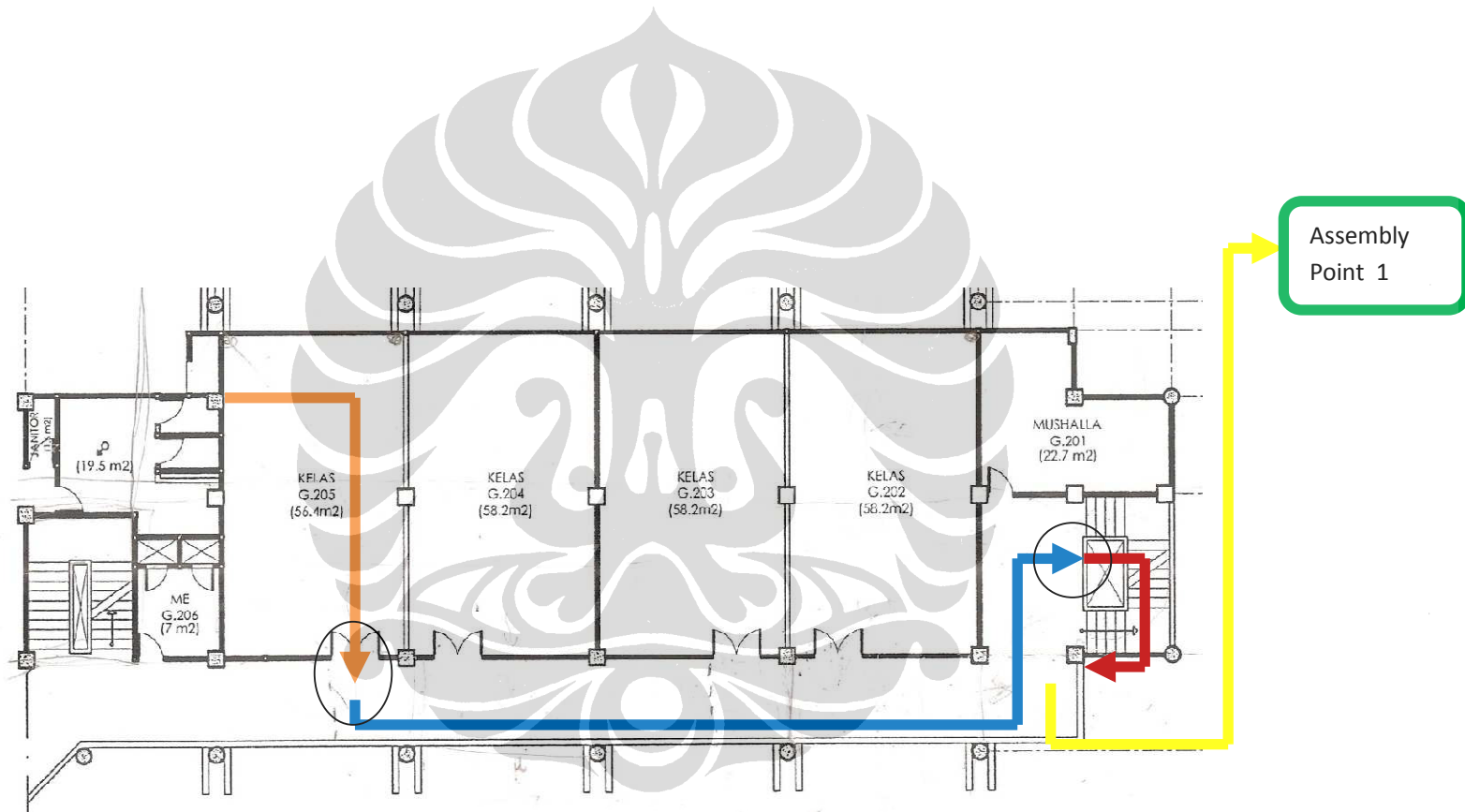

Lampiran 29. Rute Evakuasi di G203 ke Assembly Point 1

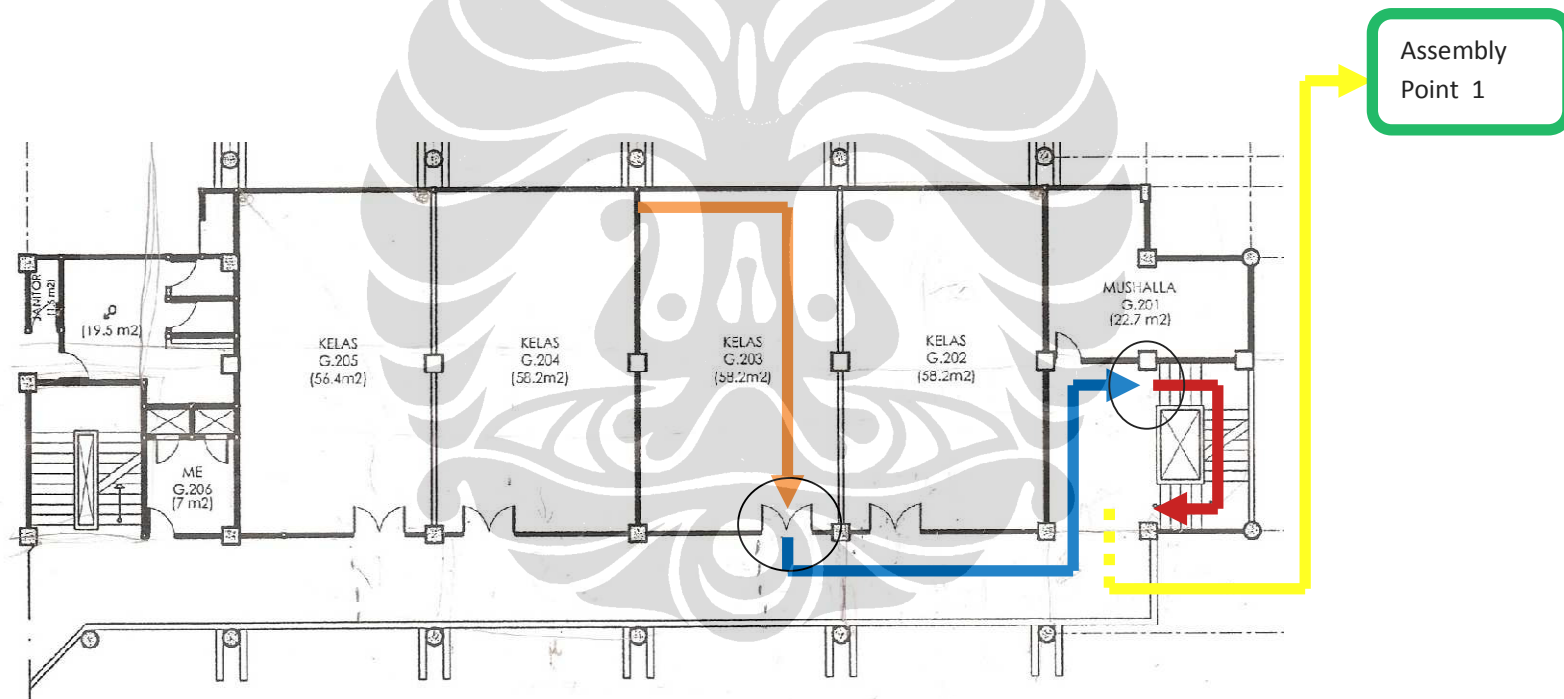

Lampiran 30. Rute Evakuasi di G202 ke Assembly Point 1

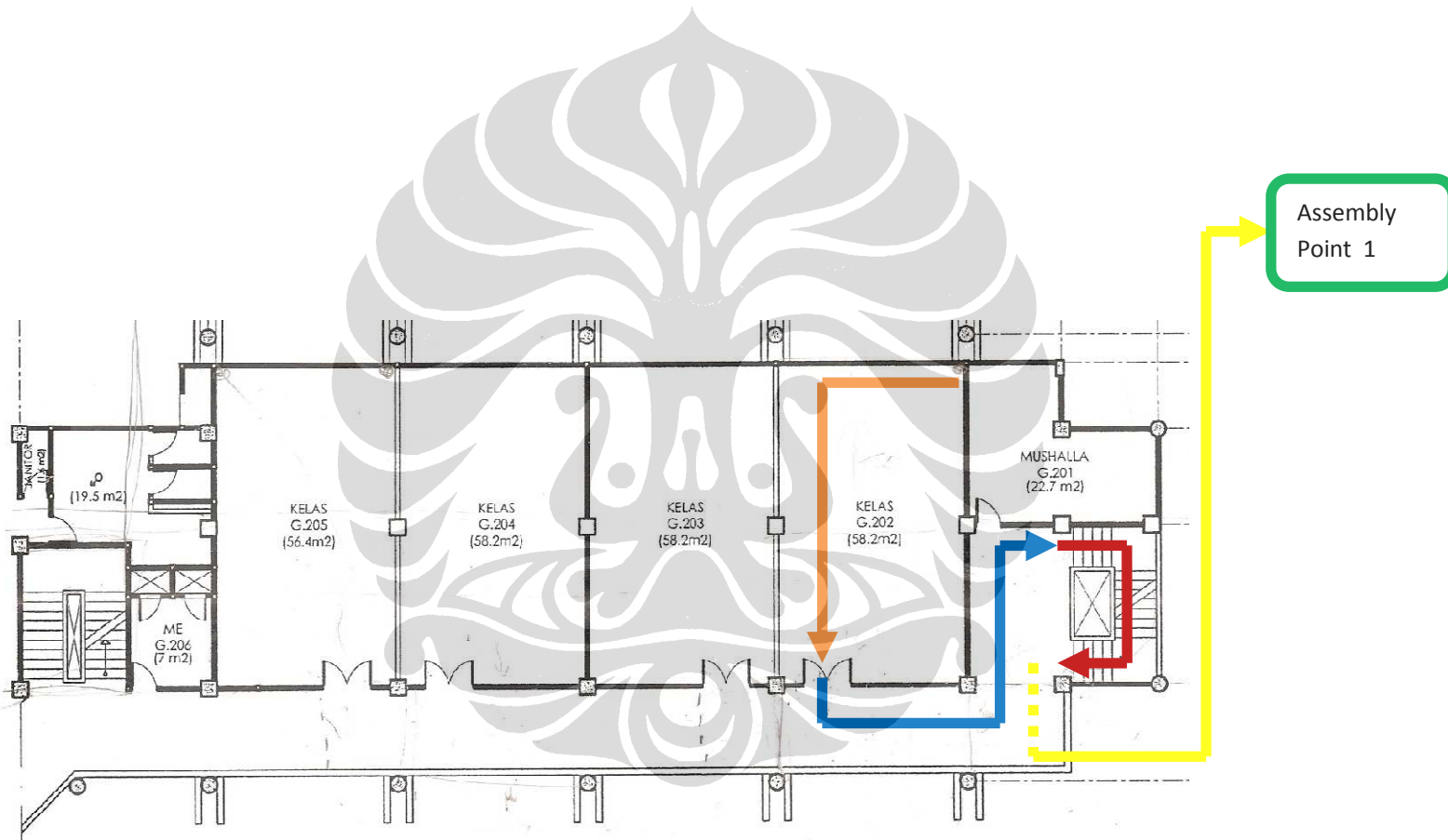

Lampiran 31: Rute Evakuasi di Ruang G205 ke *Assembly Point 2*

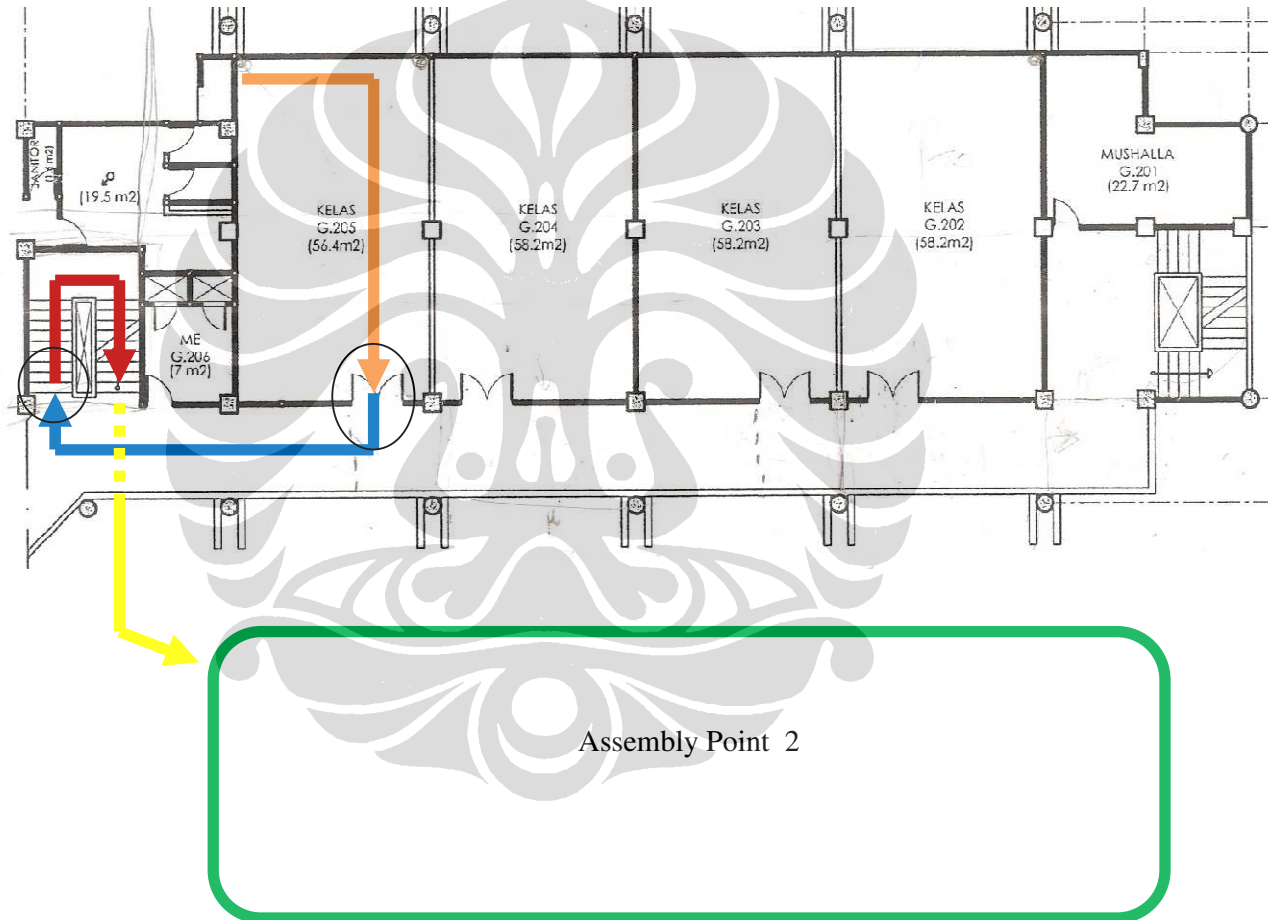

Lampiran 32: Rute Evakuasi di Ruang G204 ke *Assembly Point 2*

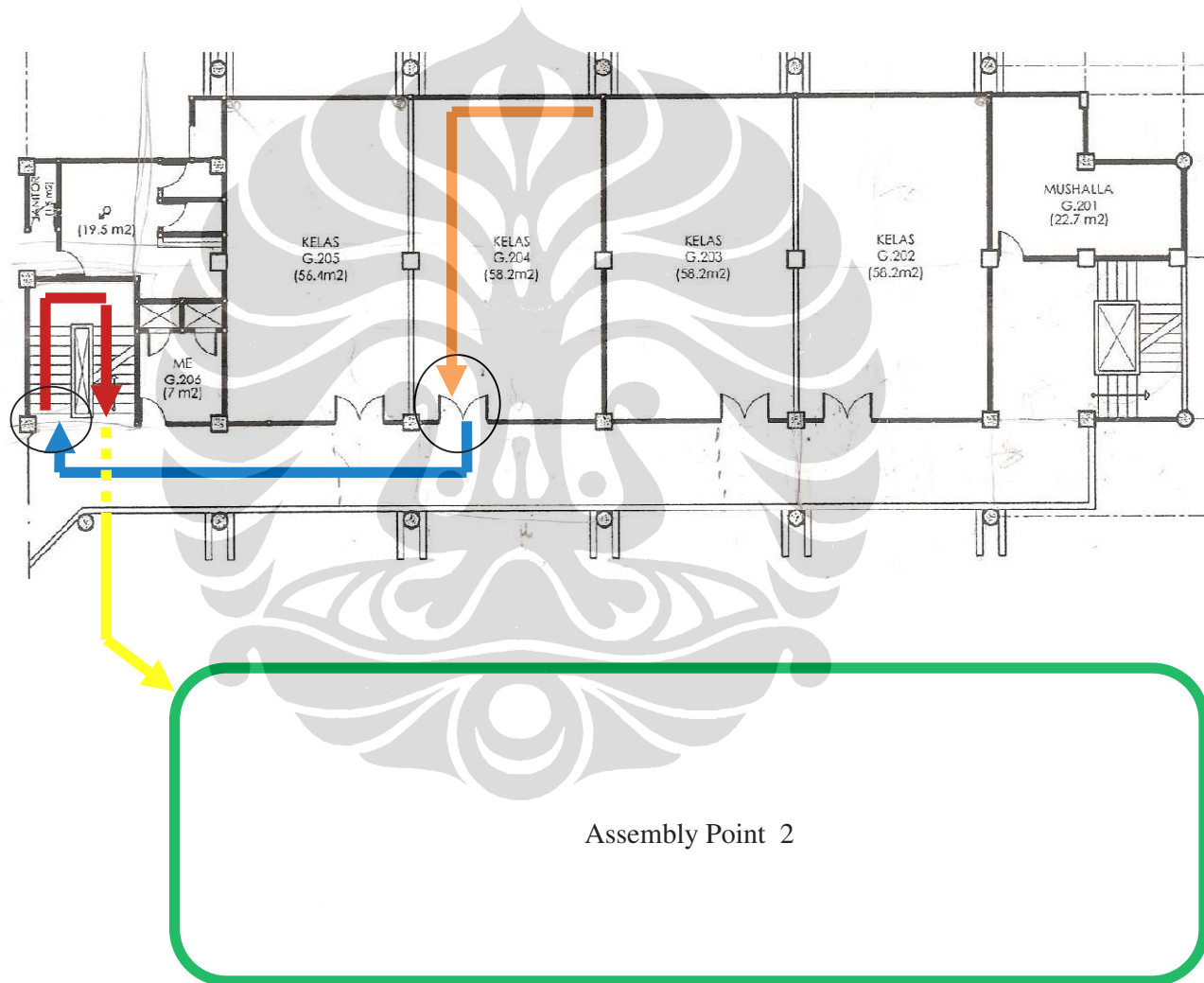

Lampiran 33: Rute Evakuasi di Ruang G203 ke *Assembly Point 2*

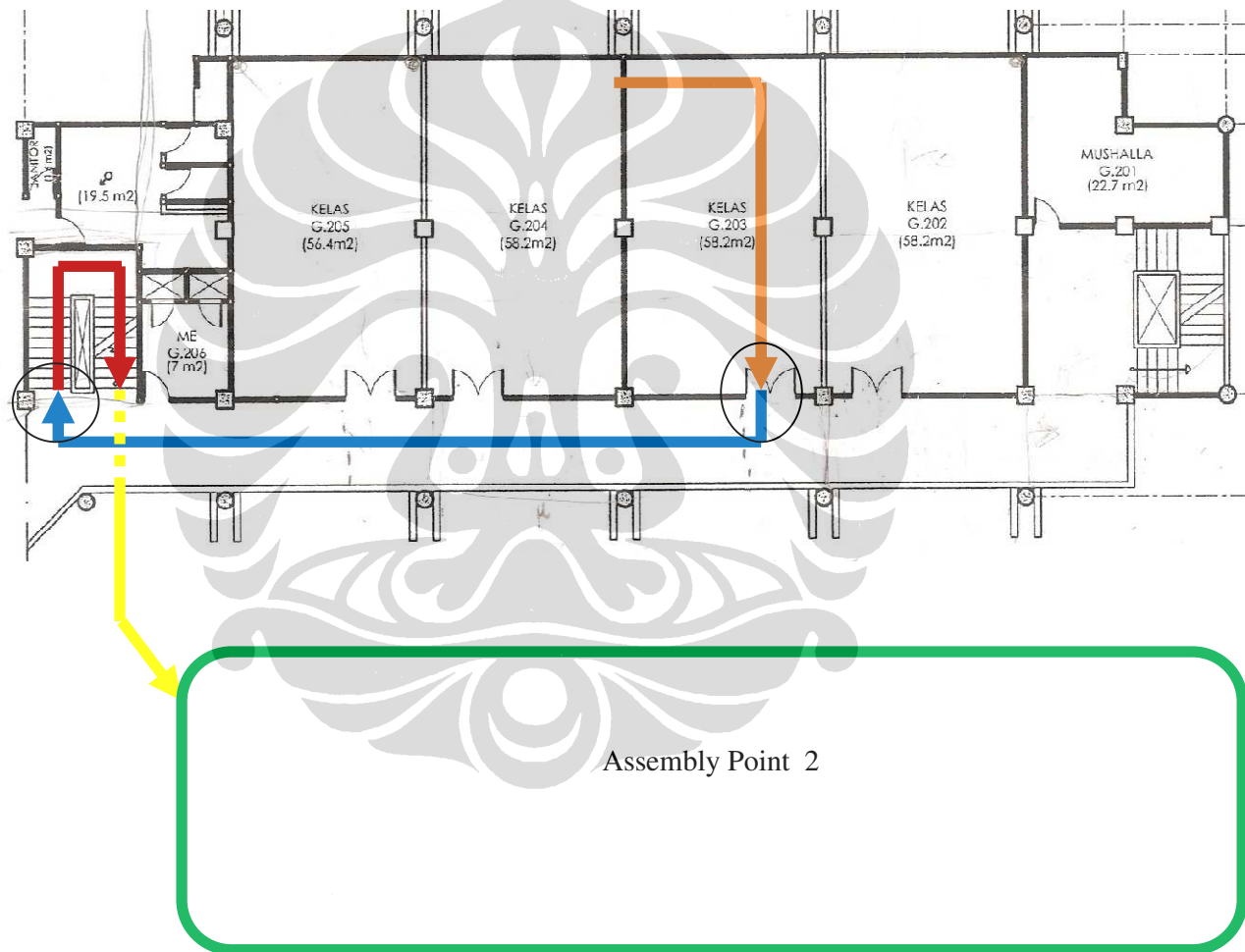

Lampiran 34: Rute Evakuasi di Ruang G202 ke *Assembly Point 2*

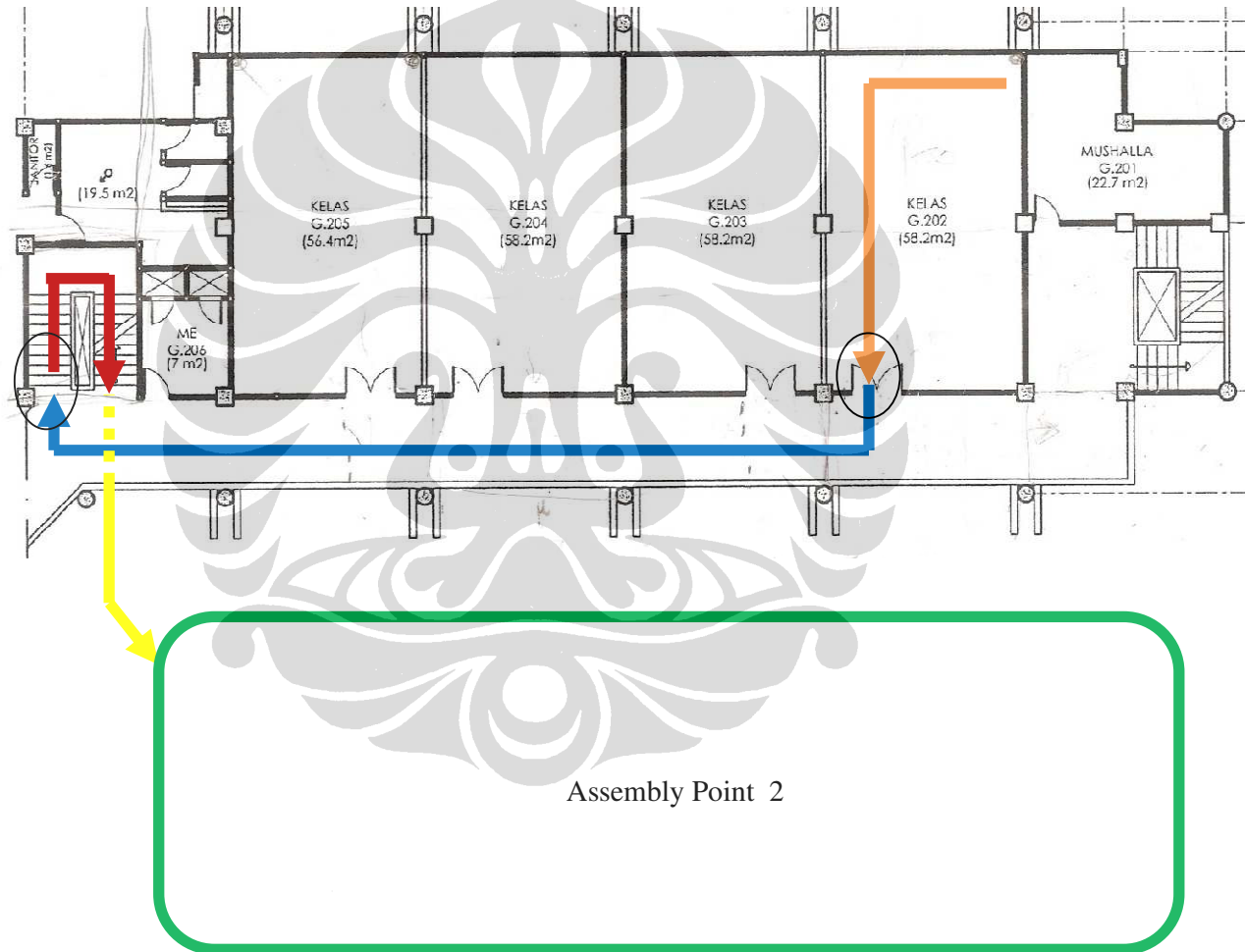

Lampiran 36: Rute Evakuasi di Ruang G2304 ke Assembly Poi

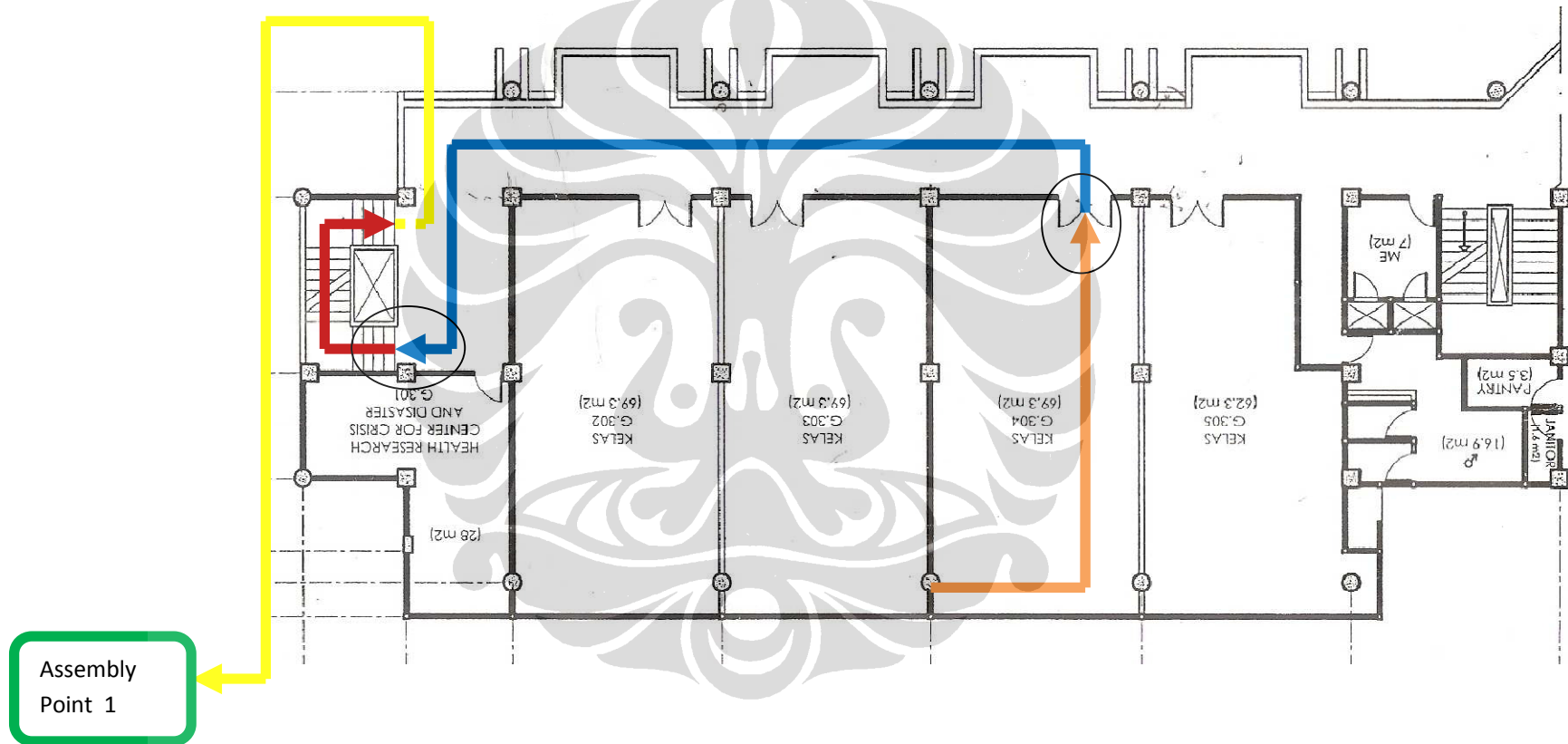

Lampiran 37: Rute Evakuasi di Ruang G303 ke *Assembly Pc*

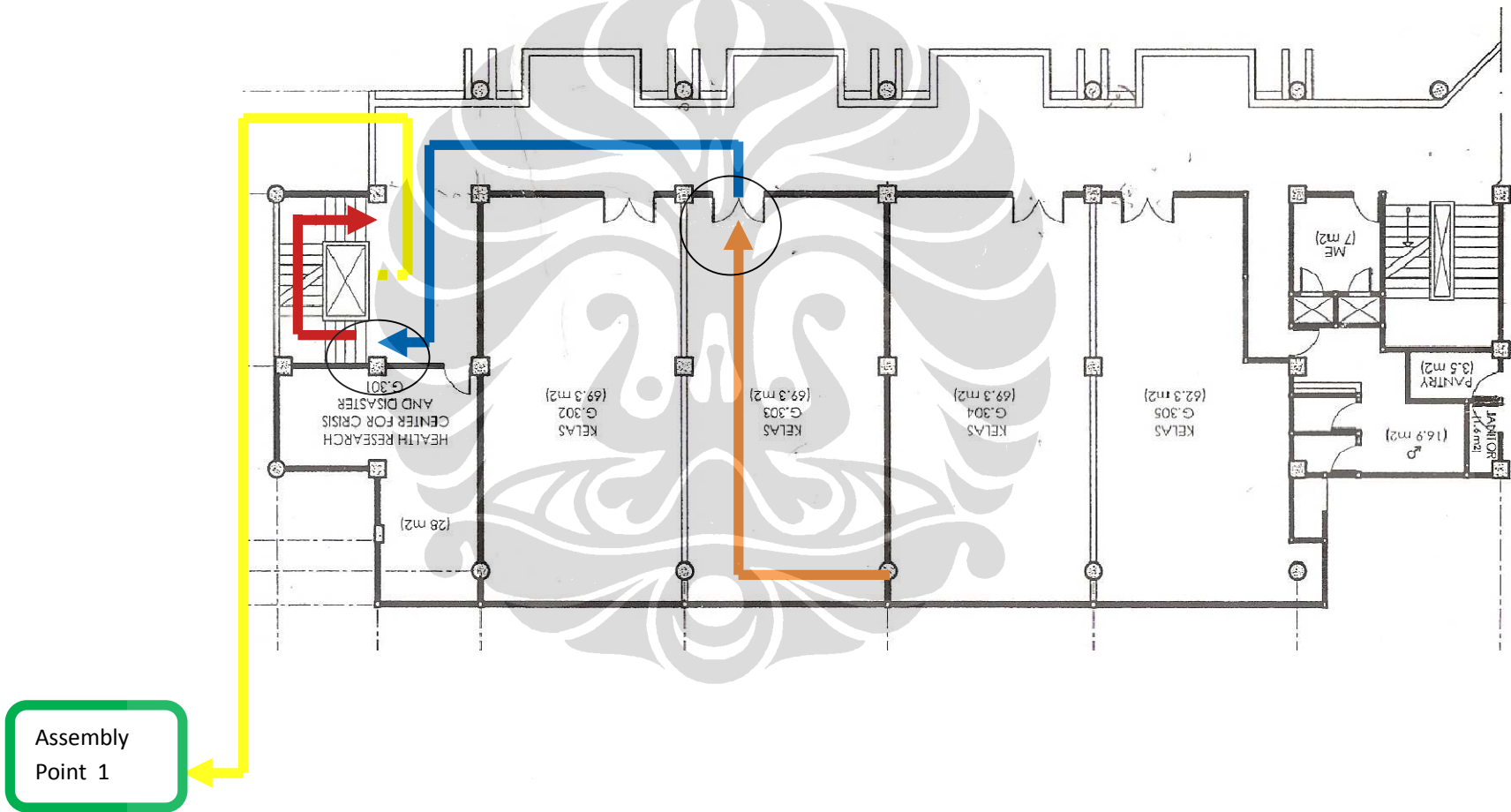

Lampiran 38: Rute Evakuasi di Ruang G302 ke *Assembly Point*

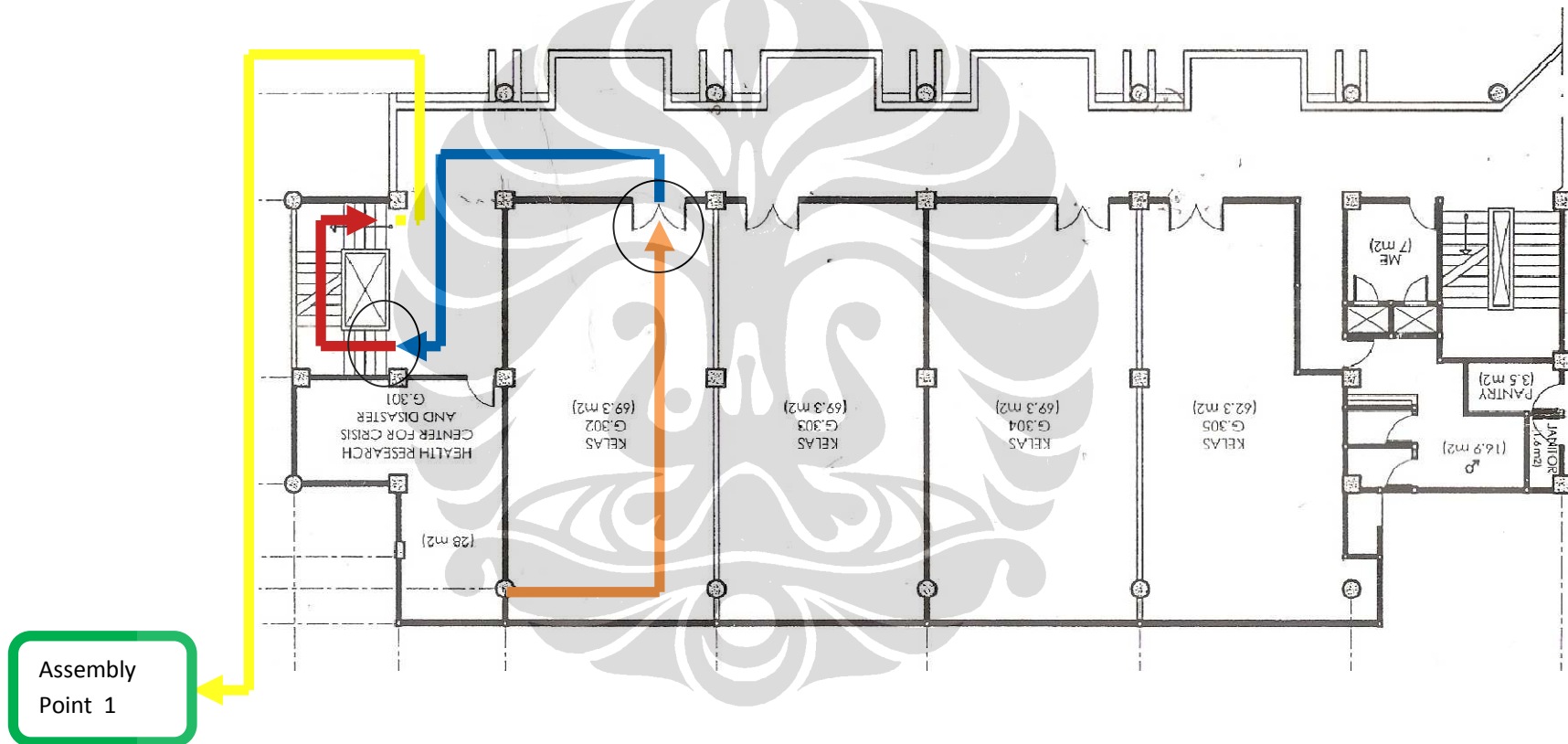

Lampiran 39: Rute Evakuasi di Ruang G305 ke *Assembly Point 2*

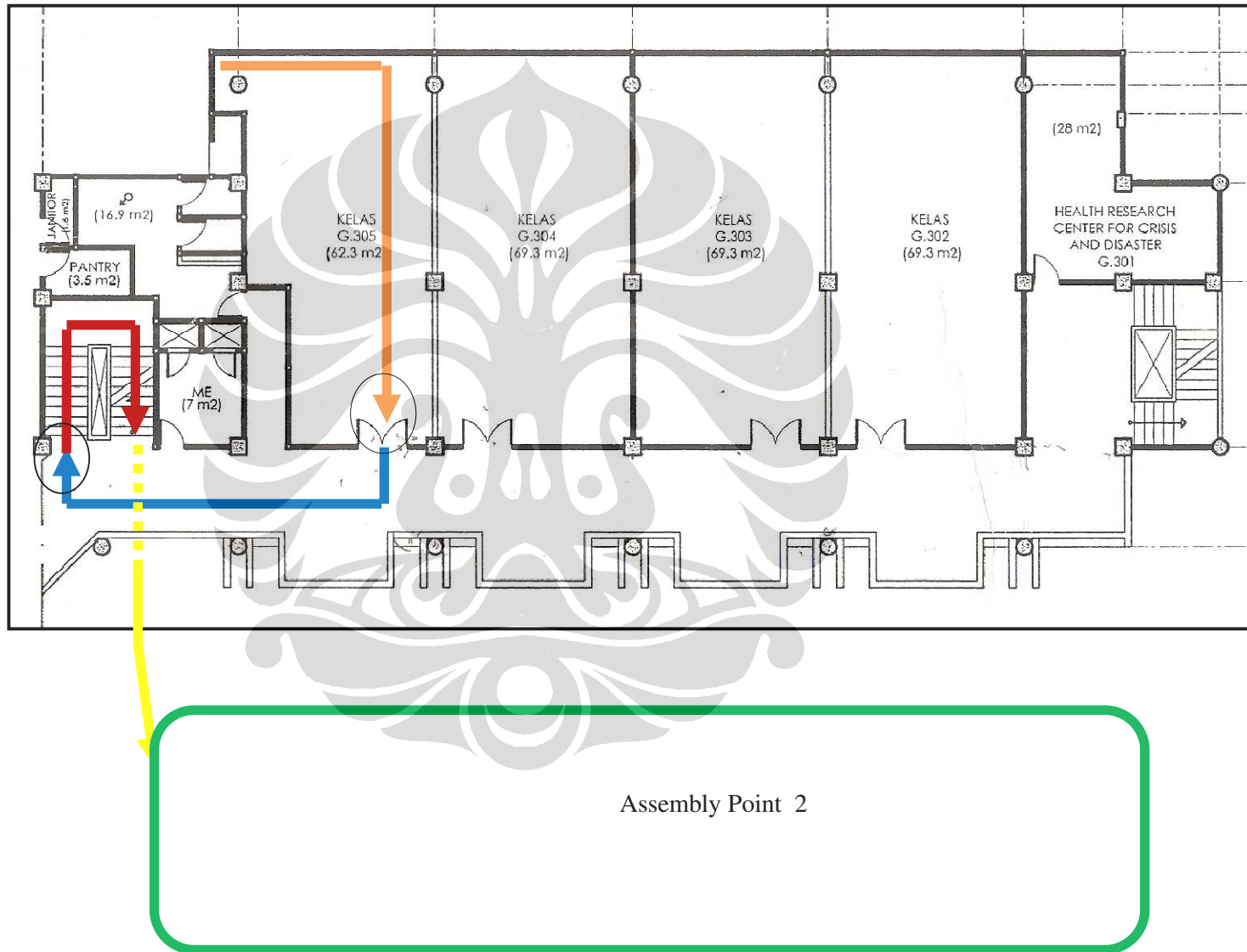

Lampiran 40: Rute Evakuasi di Ruang G304 ke *Assembly Point*

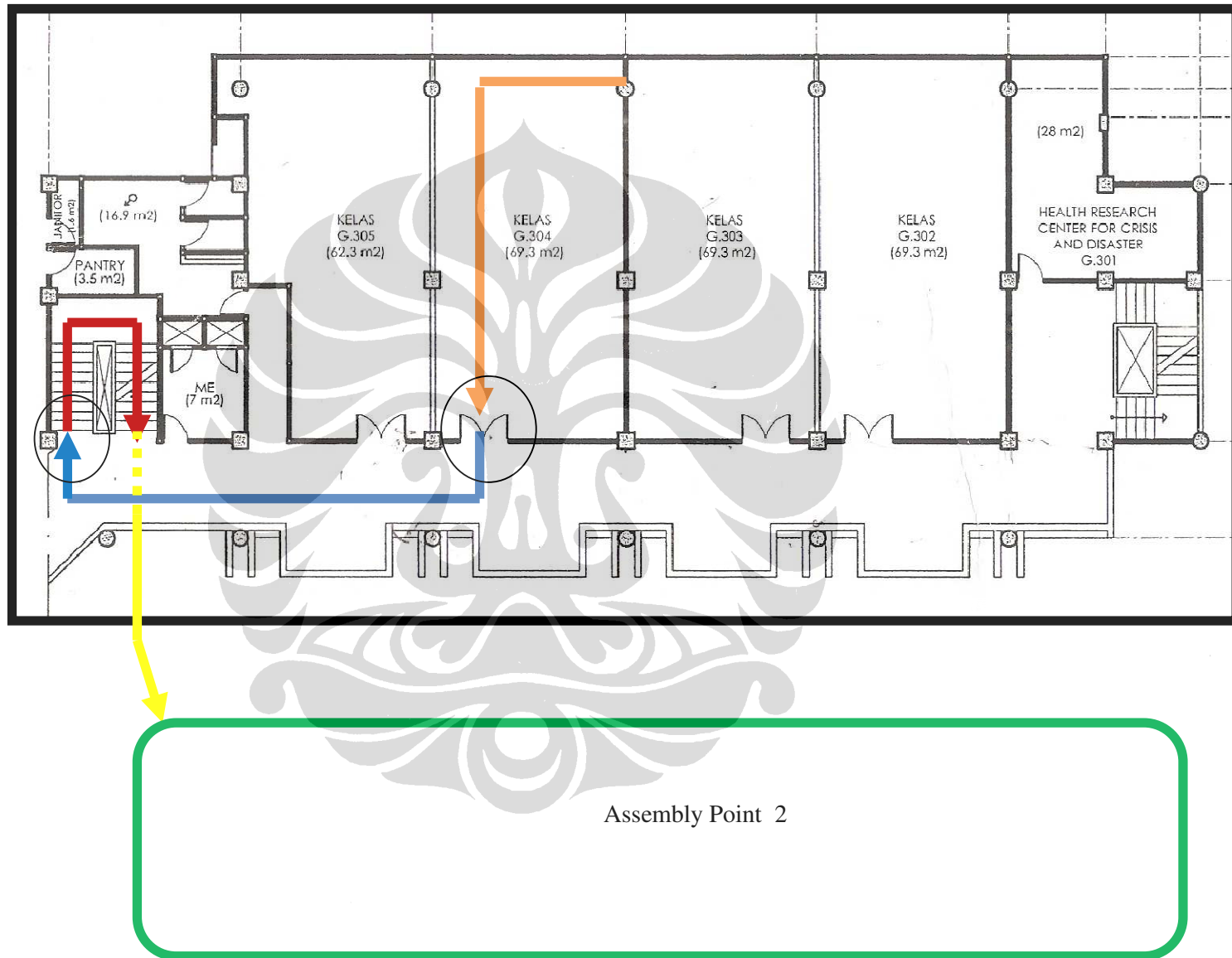

Lampiran 41: Rute Evakuasi di Ruang G303 ke *Assembly Point*

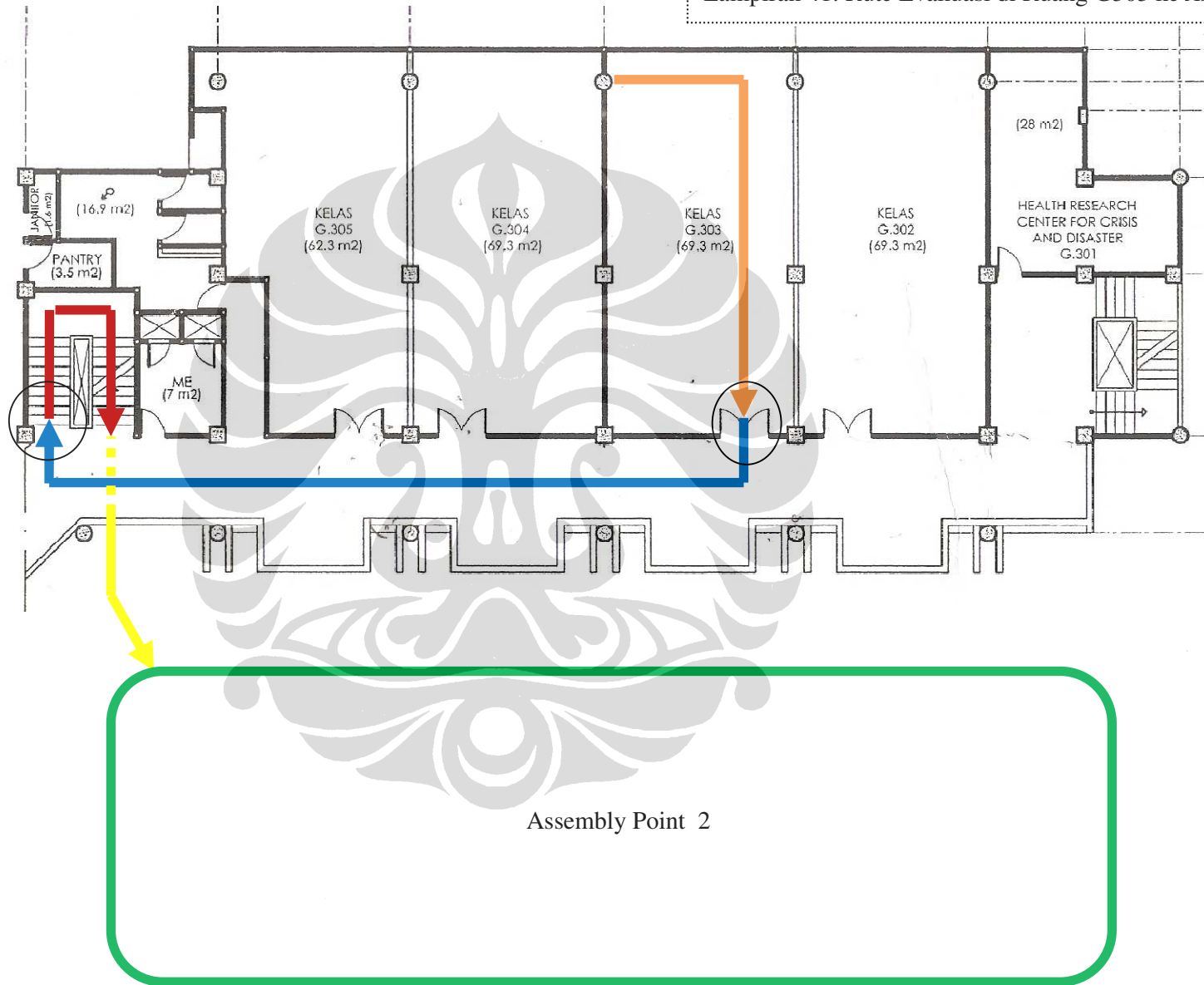

Lampiran 42: Rute Evakuasi di Ruang Gg302 ke *Assembly Point 2*

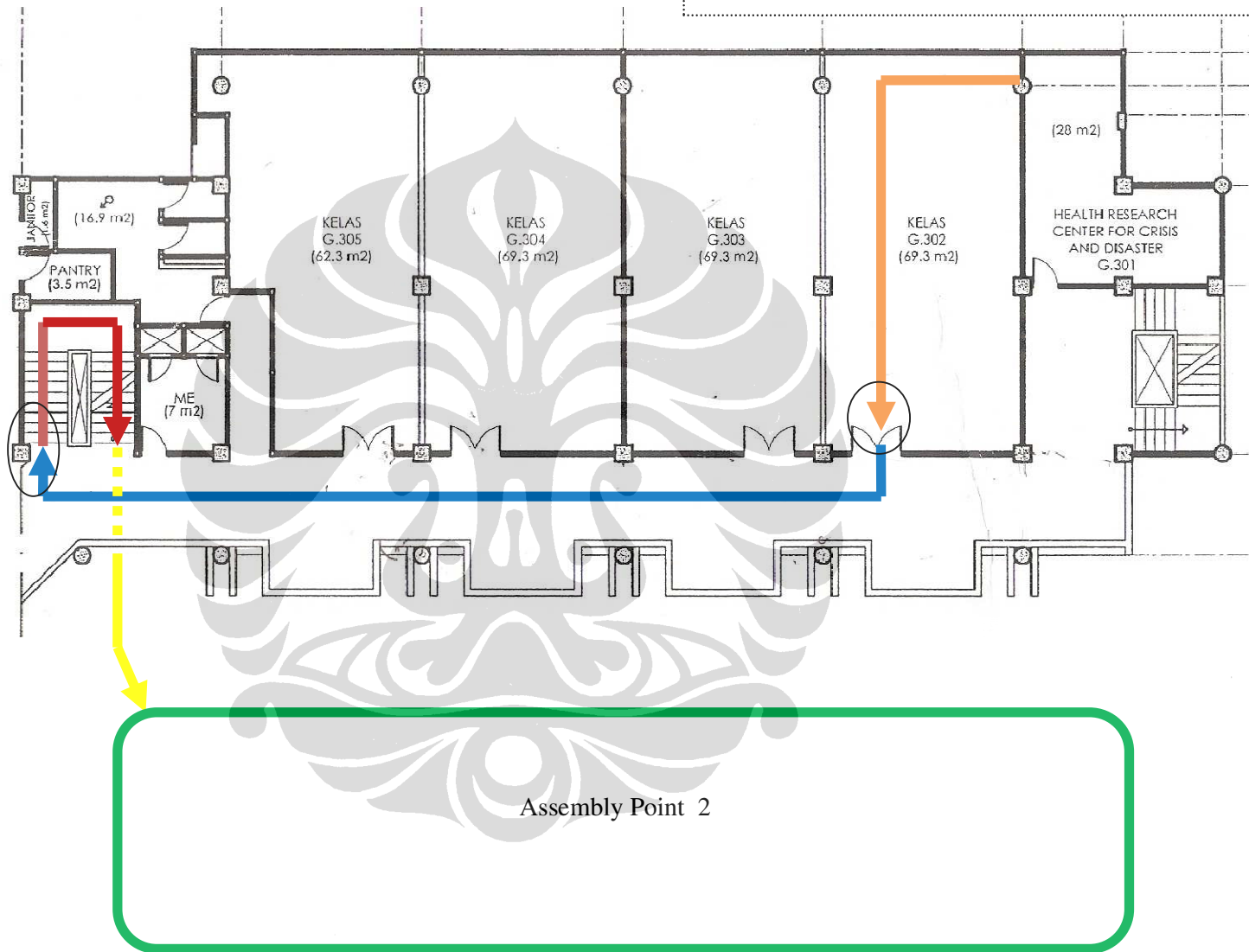

Lampiran 43: Rute Evakuasi di Ruang G402 ke *Assembly Point*

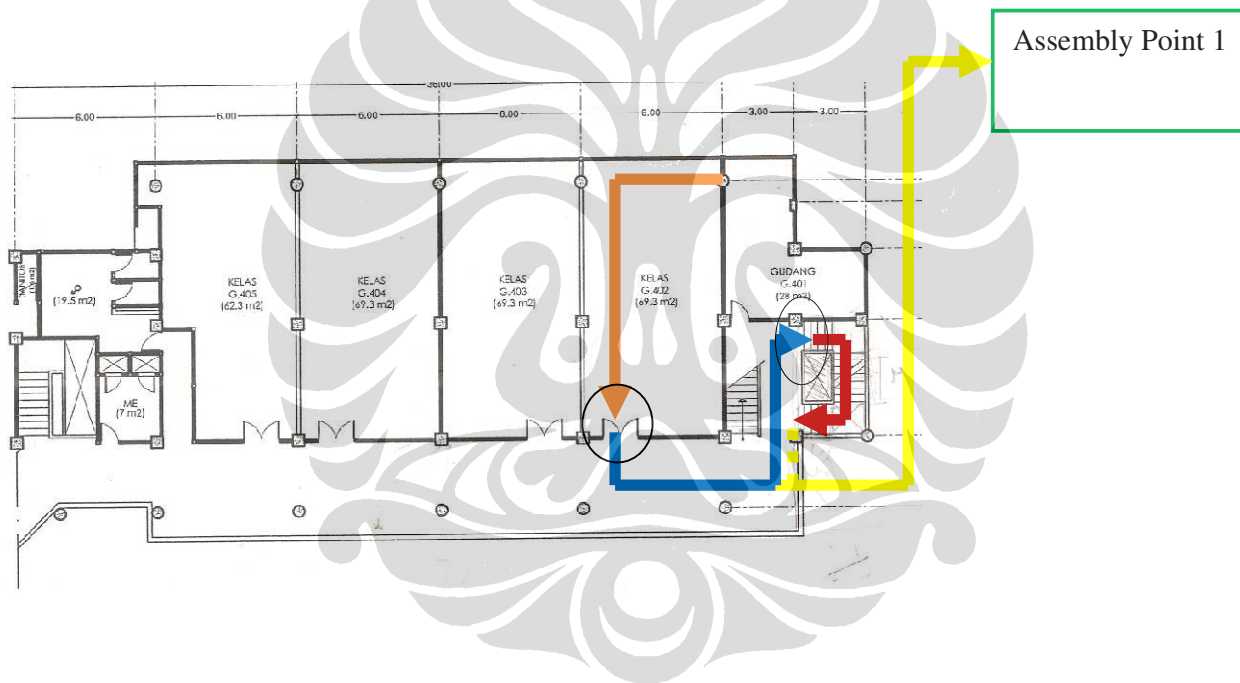

Lampiran 44: Rute Evakuasi di Ruang G403 ke *Assembly Po*

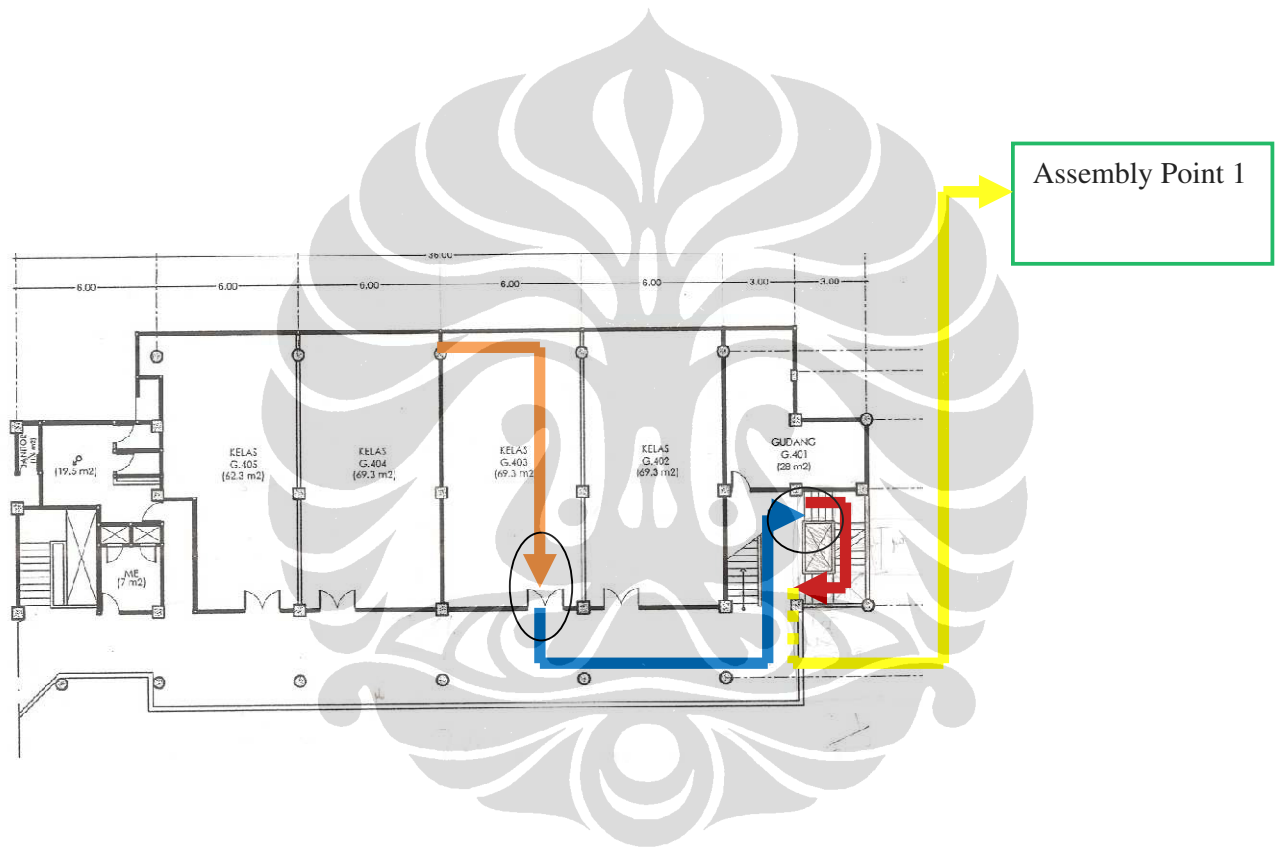

Lampiran 45: Rute Evakuasi di Ruang G404 ke *Assembly Point*

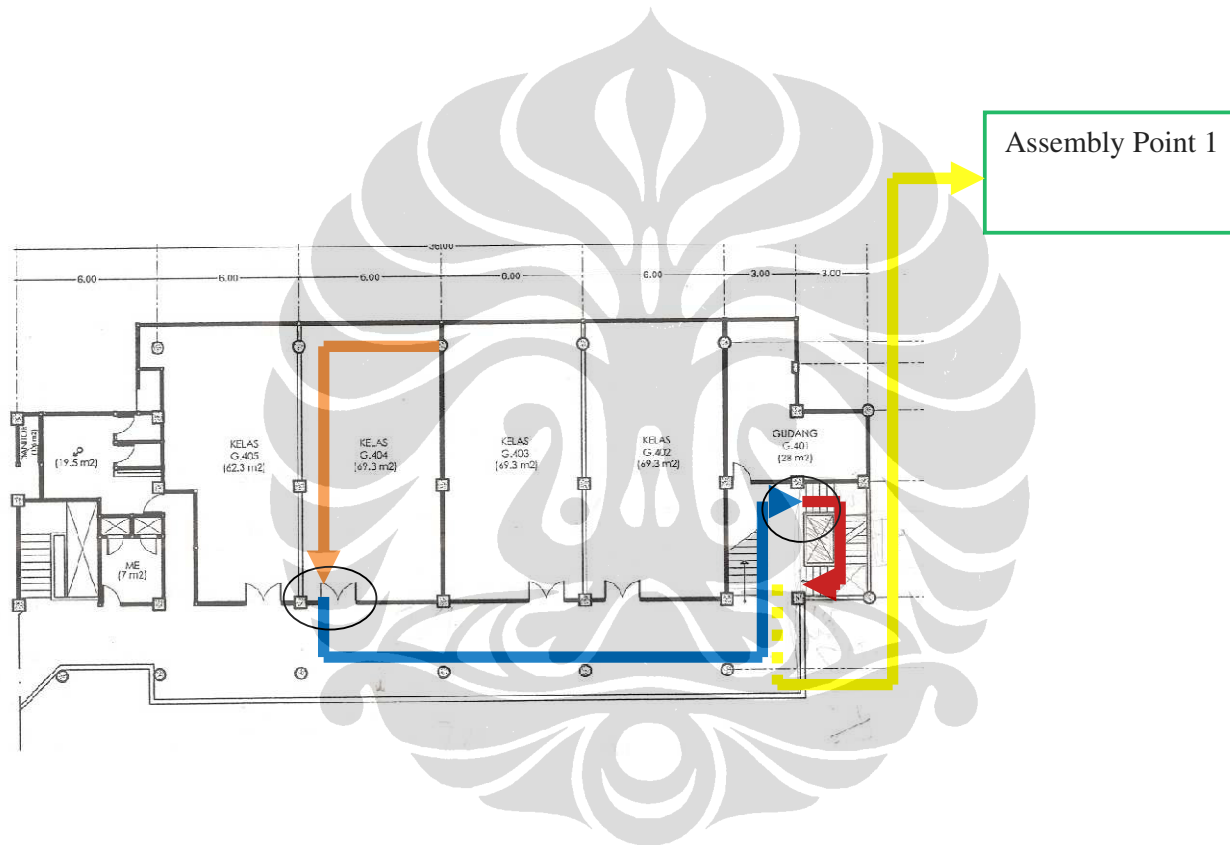

Lampiran 47: Rute Evakuasi di Ruang G405 ke *Assembly Point*

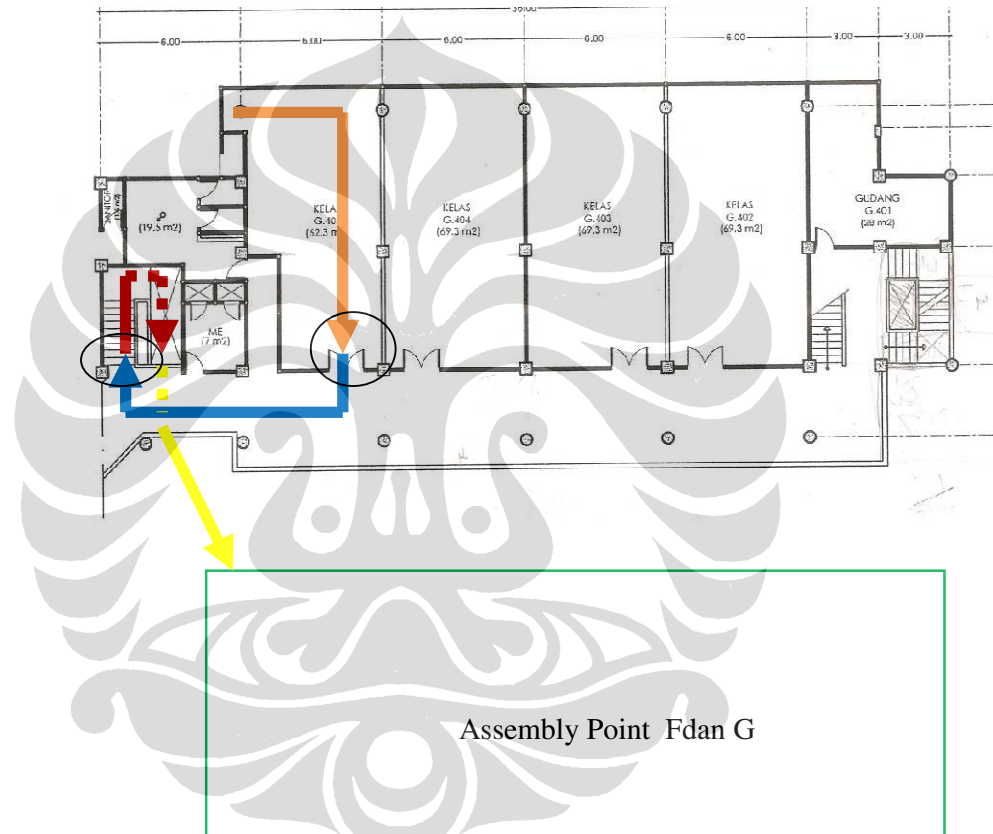

Lampiran 48: Rute Evakuasi di Ruang G404 ke *Assembly Po*

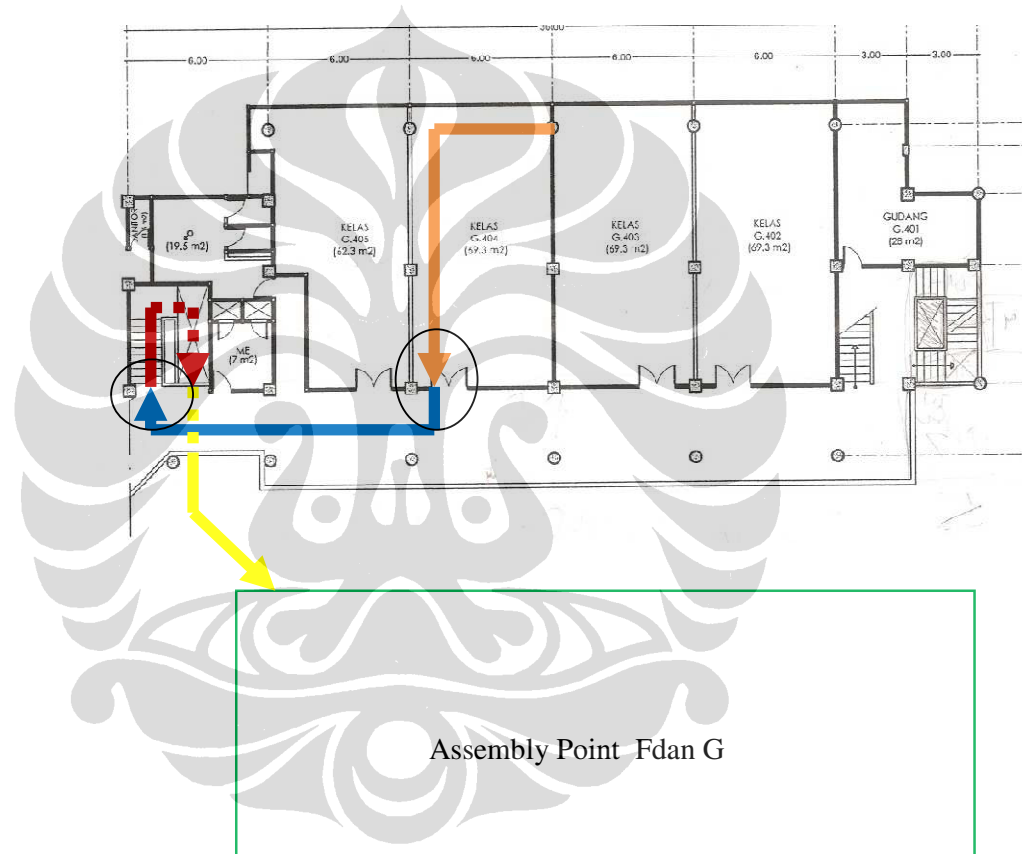

Lampiran 49: Rute Evakuasi di Ruang G403 ke *Assembly Point 2*

